

Ball Rail Tables TKL

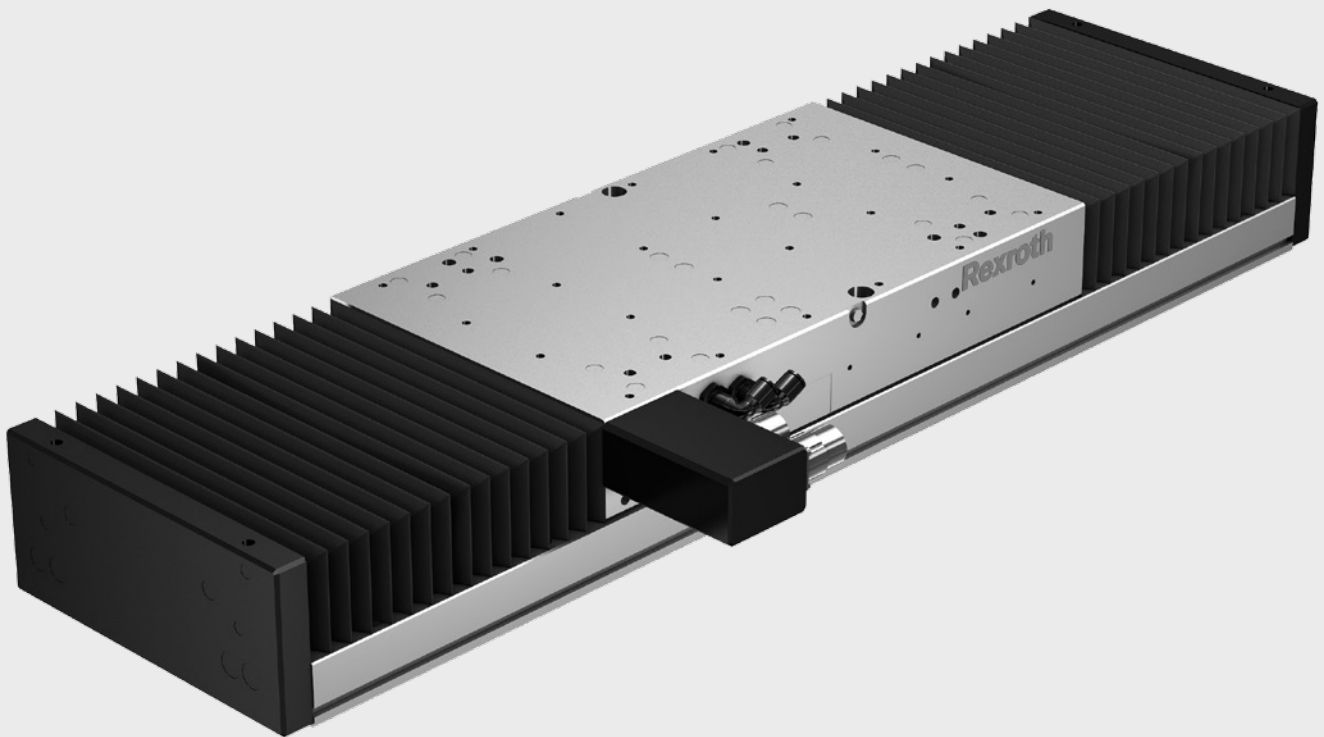

Identification system for short product names

The Ball Rail Tables are designated according to type and size.

Short product name	Example:	T	K	L	-	275	-	N	N	-	2
System	= Ball Rail Table (T)										
Guideway	= Ball Rail System (K)										
Drive	= Linear Motor (L)										
Size	= 225 / 275 / 325										
Version	= Standard version (N)										
Generation	= Product generation 2										

Changes/additions at a glance

Catalog structure

- New catalog number
- New short product name
- New catalog structure
- Content revision of all catalog pages
- "Delivery form" section added
- "Linear motor" section added
- "Connection overview" section added
- "Switching system" section added

Technical changes

- Introduction of the Integrated Measuring System IMS-A (absolute)
- New option numbers for guideway option
- New option numbers for position measuring system option
- Change from switch with loose cable end to switch with plug M8 x1
- New option numbers for switch option
- Change in switch version on the plug holder (new design of power and encoder cable required)
- Ball Runner Block changed to BSHP version
- Increased dynamic load ratings

Ball Rail Tables TKL

Product description	4
Delivery form	5
Overview of types with load capacities	6
Structure, mounting	7
Travel accuracy	8
Technical data	10
Guide system	10
Drive system ¹⁾	12
Configuration, ordering, dimension drawings, options	16
TKL-225	16
TKL-275	20
TKL-325	24
Linear motor	28
Position measuring system	30
Clamping unit	32
Connection overview	34
Attachments and accessories	36
Switching system	36
Extensions	42
Distributors	46
Extensions for passive distributors	48
Cable drag chain	52
Service and information	54
Documentation	54
Lubrication	56
Order example	56
Inquiry/order form	57
Further information	58

Product description

Ball Rail Tables TKL with Ball Rail System and iron-core Linear Motor from Rexroth are particularly suited for use where electromechanical axes are limited due to their dynamics, precision, rigidity and/or maintenance requirements.

Outstanding features

- **Easy to install and use:** Fully integrated Linear Motor System as a ready-to-install solution for design engineers.
- **High speeds and high acceleration:** Synchronous direct linear drive. High overload factor and high dynamics are possible.
- **Precise motion and high dynamic response for life:** Thrust generated directly at the payload. There is no mechanism converting rotary to linear motion, no transmission for high rigidity. Linear high-resolution position sensing system.
- **Permits very high load cycle rates:** Excellent heat dissipation thanks to liquid cooling of primary part.
- **Easy maintenance:** Little maintenance effort required due to the low-wear direct drive and the easy-to-maintain guide system.

Further highlights

- Openly configurable thanks to a variety of options
- Extremely compact precision aluminum profile with fly-cut rail seat, reference edge, and base area for optimal travel.
- The Ball Rail Systems are easy to maintain due to the central lube port on each side of the carriage.
- Built-in elements are protected by high-quality, welded high-speed bellows resistant to oil and moisture.
- Clamping unit is optional
- High Precision Ball Runner Blocks

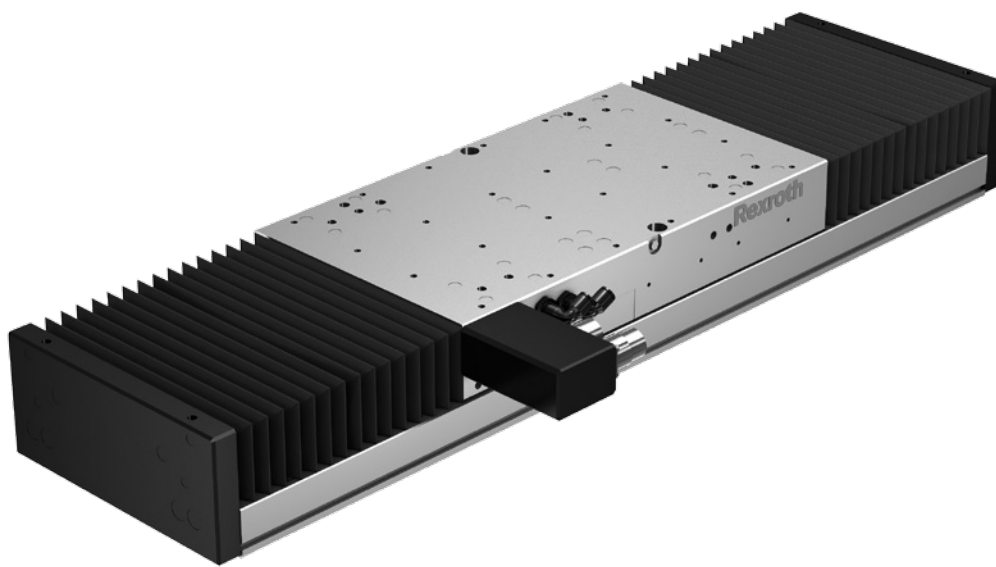

Delivery form

Ball Rail Tables TKL with Ball Rail System and iron-core Linear Motor are delivered fully assembled and with the specified documentation.

The assembly of the TKL includes the guide, the drive (Linear Motor), the carriage, the cover, the position measuring system and end position cushioning. Key components are:

Ball Rail System BSHP with Integrated Position Measuring System IMS from Rexroth

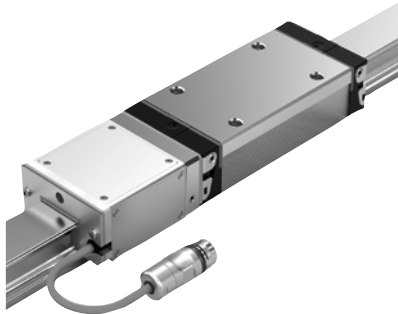

Linear motor MLF from Rexroth



Available options and accessories

Switches, switch tabs and cable ducts are selectable options and are delivered as separate part. Cable drag chains and switch accessories are included as accessories.

Suitable electric drive and control technology

Bosch Rexroth can also provide the suitable electrical drive and control technology for operating the Ball Rail Table TKL on request. Servo controller, control and electrical accessories are delivered separately.

For further information, see "Rexroth IndraDrive drive system, R999000018" and "Automation systems and control components, R999000026". Key component is:

Drive system HCS from Rexroth



Required and supplementary documentation

For further instructions and information, please refer to the documentation for this product.

You can find PDF files of these documents on the Internet at www.boschrexroth.com/mediadirectory

We would also be happy to send you the documents you want.

If you are unsure about using this product, please contact Bosch Rexroth.

Overview of types with load capacities

Acceptable loads (Recommended values based on experience)

In relation to the desired service life, loads for F_m , F_{comb} of up to about 20% of the dynamic load rating C have proven effective.

See the section on calculation principles.

Do not exceed the technical data for the linear system.

F_m = Dynamic equivalent load on bearing of the guideway

F_{comb} = Combined equivalent load on bearing of the guideway

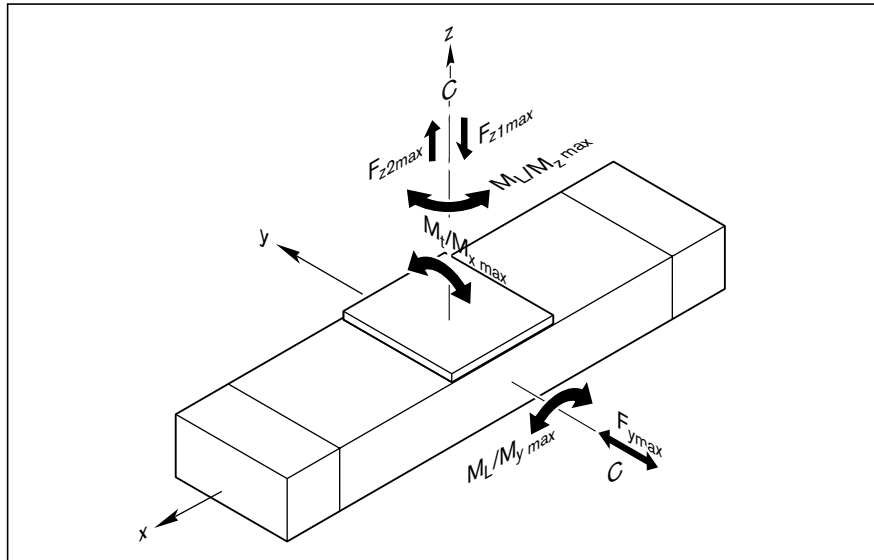

TKL	Dimensions A x H (mm)	L_{max} (mm)	Dyn. Load rating C (N) ¹⁾
TKL-225	225 x 100	3 940	96 100
TKL-275	275 x 110	3 940	121 100
TKL-325	325 x 120	3 940	149 400 (224 100) ²⁾

1) Take maximum loads into account.

2) Only for version with primary part C or table length 775 mm.

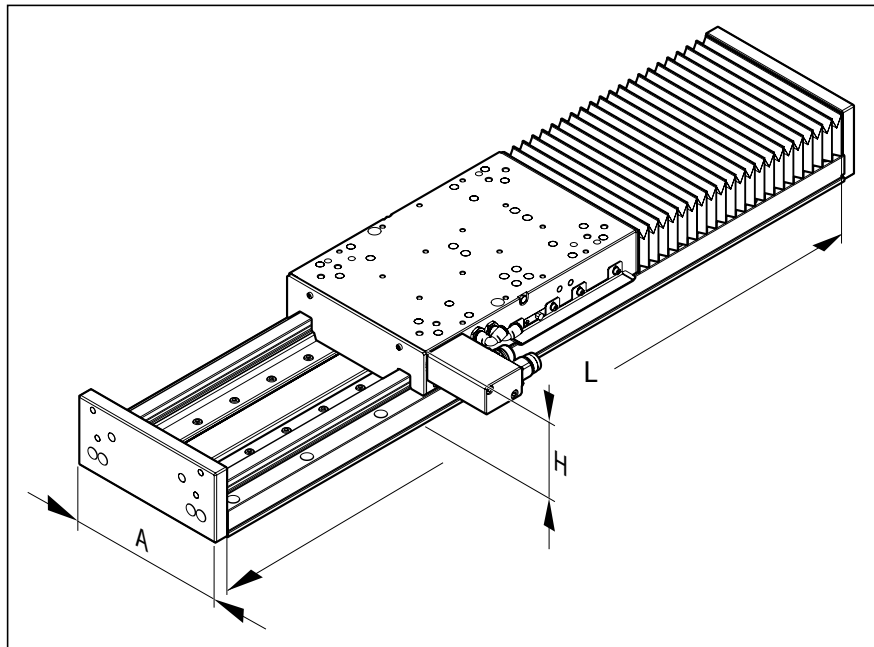

Structure, mounting

- 1 End plate
- 2 Guide rail with integrated scale
- 3 Linear motor secondary part
- 4 Guide rail
- 5 Carriage (aluminum)
- 6 Linear motor primary part
- 7 Scanner with sensors
- 8 Ball Runner Block (four or six pieces)
- 9 PU bellows cover (optional)
- 10 Rubber buffer
- 11 Base plate (aluminum)
- 12 Plug holder for motor flange socket and position measuring system
- 13 Clamping unit (optional)

Attachments:

- 14 Mechanical switch (with additional components)
- 15 Cable duct (aluminum alloy)
- 16 Switching cam
- 17 Proximity switch (with additional components)

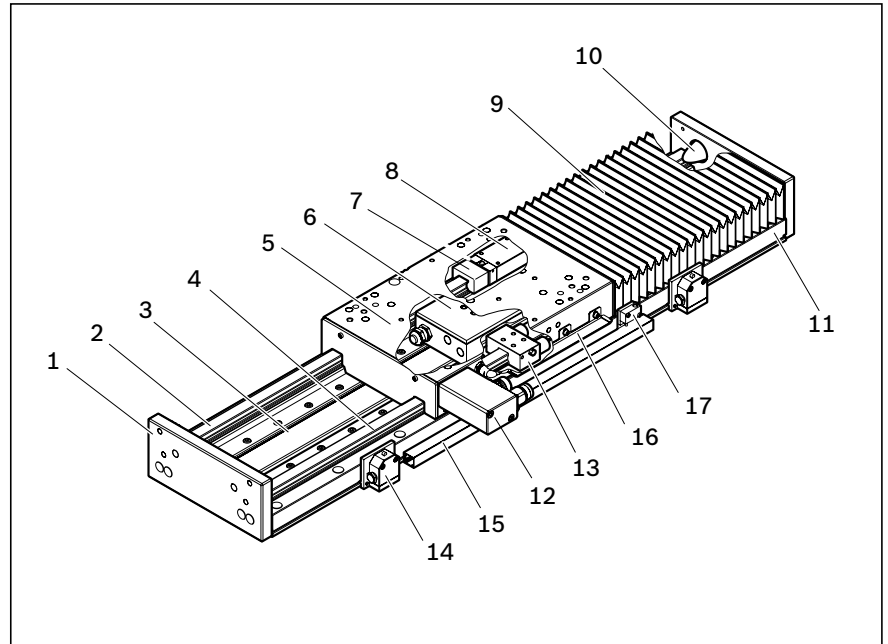

General notes on mounting

Ball Rail Tables TKL are mounted from above.

Mounting hole plugs are included with the unit.

For connection dimensions, see the relevant dimension drawings.

- 1 Mounting hole plug
- 2 Base plate
- 3 Reference edge

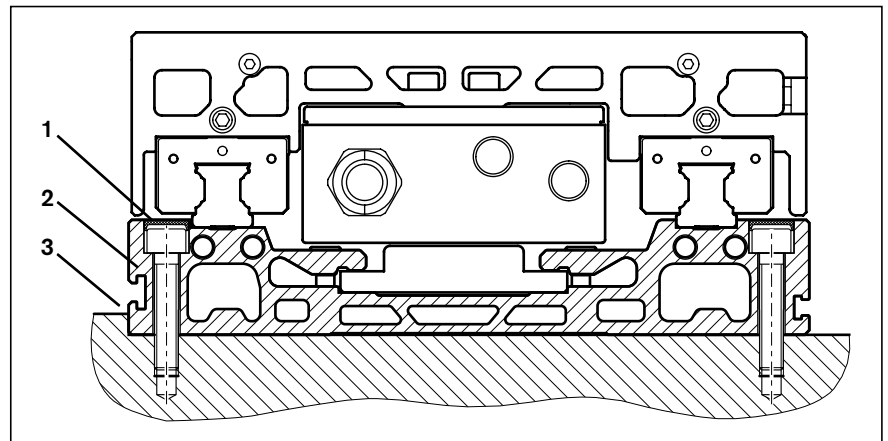

Travel accuracy

All accuracy data apply to the unit when screwed down and assume an ideally flat mounting base surface. Irregularities in the mounting base surface are not taken into account in the values given below.

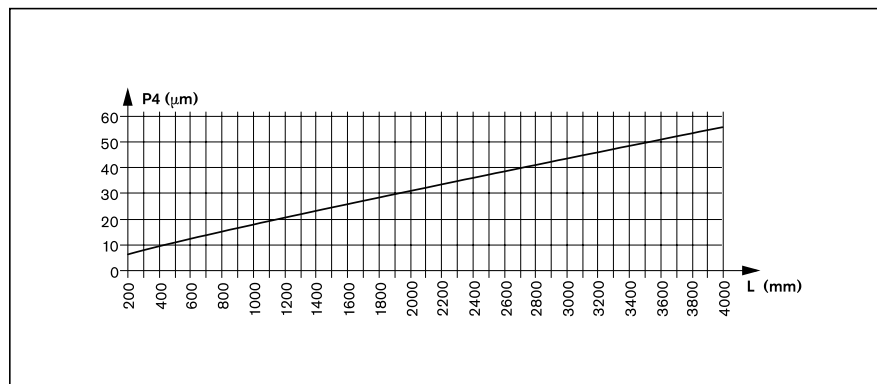
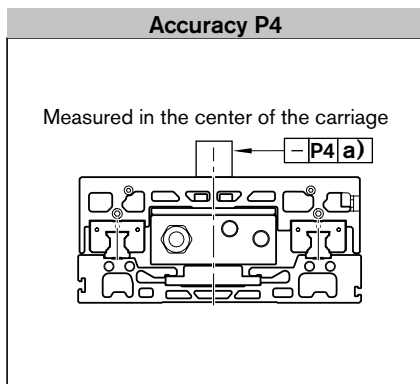
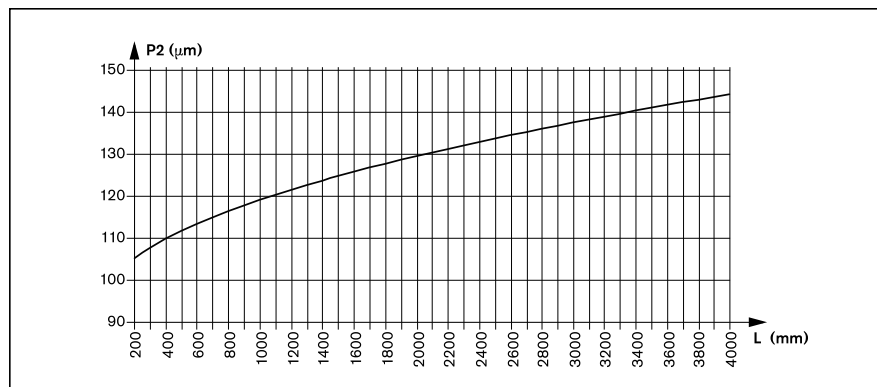
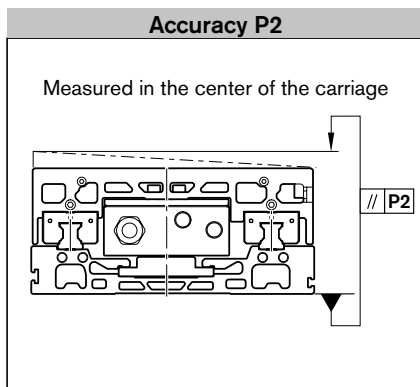
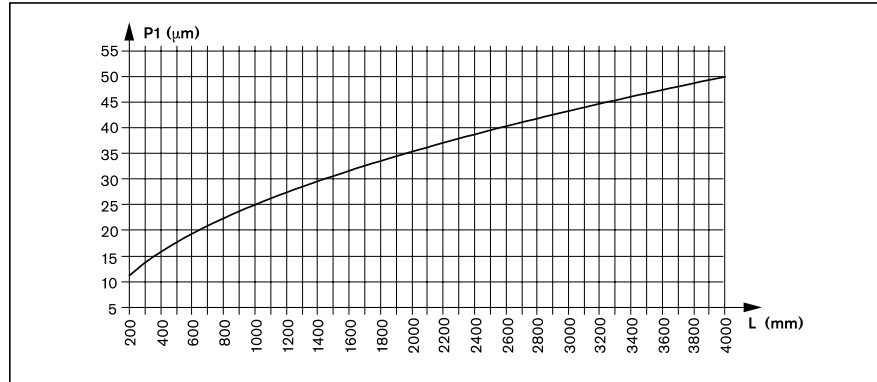
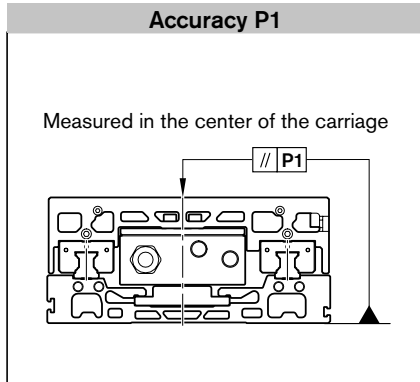

a) Lengthwise

Technical data

Guide system

TKL	Motor	Primary part	Motor winding	Encapsulation	Attractive force of the motor	Carriage length	Moved mass of system		Dimension
							TT with primary part	TT without primary part	
					F_{ATT} (N)	L_{ca} (mm)	m_{ca} (kg)	m_{ca} (kg)	Z_1 (mm)
TKL-225	MLP040	A	300	Standard encapsulation	1200	340	15.5	10.8	52.1
		B	250		1700	400	17.9	11.8	
TKL-275	MLP070	A	300		2900	395	24.2	15.8	60.4
		B	250		3750	465	27.5	17.1	
TKL-325	MLP100	A	190		5400	475	35.4	21.9	68.5
		B	250		8000	625	44.6	25.9	
		C	190		10400	775	56.1	32.1	

Calculation principles

 The attractive force of the motor must be taken into account in the calculations!

Maximum permissible loads

When selecting Linear Motion Systems, it is essential to consider the upper limits for permissible loads and forces, as specified in the section on "Technical data". The values given there are system-related. In other words, the upper limits are determined not only by the load ratings of the bearing points but also include structural design and material-related considerations.

Conditions for combined loads

$$\frac{|F_y|}{F_{y \max}} + \frac{|F_z|}{F_{z \max}} + \frac{|M_x|}{M_{x \max}} + \frac{|M_y|}{M_{y \max}} + \frac{|M_z|}{M_{z \max}} \leq 1$$

Weight calculation

TKL-225:
 $m_s = 0.027 \cdot L + 4.3 + m_{ca}$

TKL-275:
 $m_s = 0.038 \cdot L + 6.3 + m_{ca}$

TKL-325:
 $m_s = 0.048 \cdot L + 8.8 + m_{ca}$

m_s = mass of the TKL (kg)
 L = length (mm)
 m_{ca} = moved mass (kg)

Note on dynamic load capacities and load moments

Determination of the dynamic load capacities and load moments is based on a travel life of 100,000 m as per DIN ISO 14728-1. Often, only 50 000 m are used as a basis, however.

For comparison:
 Multiply values **C**, **M_t**, and **M_L** from the table by 1.26.

	Dynamic load capacities		Dynamic load moments		Maximum permissible loads						Maximum length L _{max} (mm)	Planar moment of inertia	
	C (N)	M _t (Nm)	M _L (Nm)	Forces			Moments			J _y (cm ⁴)		J _z (cm ⁴)	
				F _{z1 max} (N)	F _{z2 max} (N)	F _{y max} (N)	M _{x max} (Nm)	M _{y max} (Nm)	M _{z max} (Nm)				
	96 100	7 600	10 400	32 100	29 200	19 800	2 330	3 180	2 150	3940	121	3132	
	96 100	7 600	12 900	32 100	29 200	19 800	2 330	3 940	2 670	3940	121	3132	
	121 100	12 100	14 600	46 800	43 200	23 400	4 320	5 220	2 830	3940	170	6204	
	121 100	12 100	18 200	46 800	43 200	23 400	4 320	6 520	3 530	3940	170	6204	
	149 400	17 900	22 400	89 000	84 400	30 800	10 120	12 660	4 620	3940	223	10 492	
	149 400	17 900	32 500	89 000	84 400	30 800	10 120	18 390	6 710	3940	223	10 492	
	224 100	26 800	42 700	89 000	84 400	30 800	10 120	24 130	8 800	3940	223	10 492	

Combined equivalent load on bearing of the linear guide

$$F_{comb} = |F_y| + |F_z| + C \cdot \frac{|M_x|}{M_t} + C \cdot \frac{|M_y|}{M_L} + C \cdot \frac{|M_z|}{M_L}$$

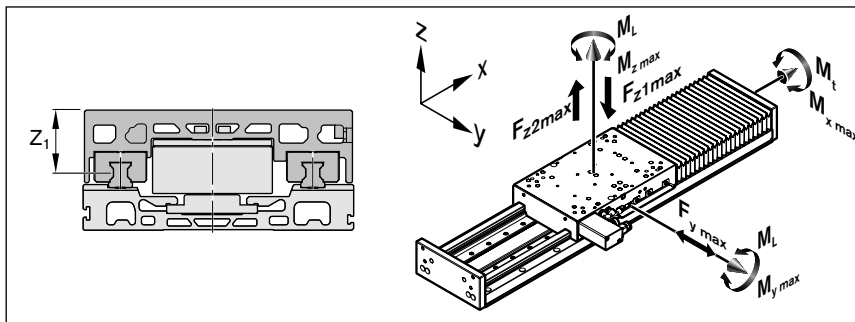

- C = dynamic load capacity (N)
- F_{comb} = combined equivalent load on bearing (N)
- F_{y max} = force in y-direction (N)
- F_{z max} = force in z-direction (N)
(Take into account the motor attractive force)
- L = nominal life in meters (m)
- L_h = nominal life in hours (h)
- M_L = dyn. longitudinal moment load cap. (Nm)
- M_t = dyn. torsional moment load cap. (Nm)
- M_{x max} = torsional moment around the x-axis (Nm)
- M_{y max} = torsional moment around the y-axis (Nm)
- M_{z max} = torsional moment around the z-axis (Nm)
- Z₁ = application point of the effective force (mm)
- v_m = average travel speed (m/s)

Life
Nominal life of the guideway in meters:

$$L = \left(\frac{C}{F_{comb}} \right)^3 \cdot 10^5$$

Nominal life of the guideway in hours:

$$L_h = \frac{L}{3600 \cdot v_m}$$

Module of elasticity of the linear system

E = 70 000 N/mm²

Technical data

Drive system¹⁾

TKL	Motor	Primary part	Motor winding	Encapsulation	Motor attractive force ²⁾	Carriage length	Moved mass of system	
							Carriage with primary part	Carriage without primary part
					F_{ATT} (N)	L_{ca} (mm)	m_{ca} (kg)	m_{ca} (kg)
TKL-225	MLP040	A	300	Standard encapsulation	1200	340	15.5	10.8
		B	250		1700	400	17.9	11.8
TKL-275	MLP070	A	300		2900	395	24.2	15.8
		B	250		3750	465	27.5	17.1
TKL-325	MLP100	A	190		5400	475	35.4	21.9
		B	250		8000	625	44.6	25.9
		C	190		10400	775	56.1	32.1

- 1) All information is based on operation with liquid cooling (with a coolant supply temperature of 30 °C) and 540 V DC link circuit voltage.
- 2) Between the primary and secondary part at rated air gap, primary part de-energized.
- 3) The achievable forces depend on the drive controller used.
- 4) The attainable speeds are dependent on the supply voltage and its tolerance.
- 5) This limitation is due to the permissible speed of the guideway. Please ask about applications with higher speeds.
- 6) Other measured variables include: Power cable chain, wiring, customer mounting base (frame), etc.

Calculation principles

- ☞ Moved mass of system (carriage, cable drag chain and wiring) and internal friction must be taken into account in the calculation!
It is advisable to include a reserve of 10 to 20 % in the design of the linear motor and the drive controller.

Torque/speed characteristic

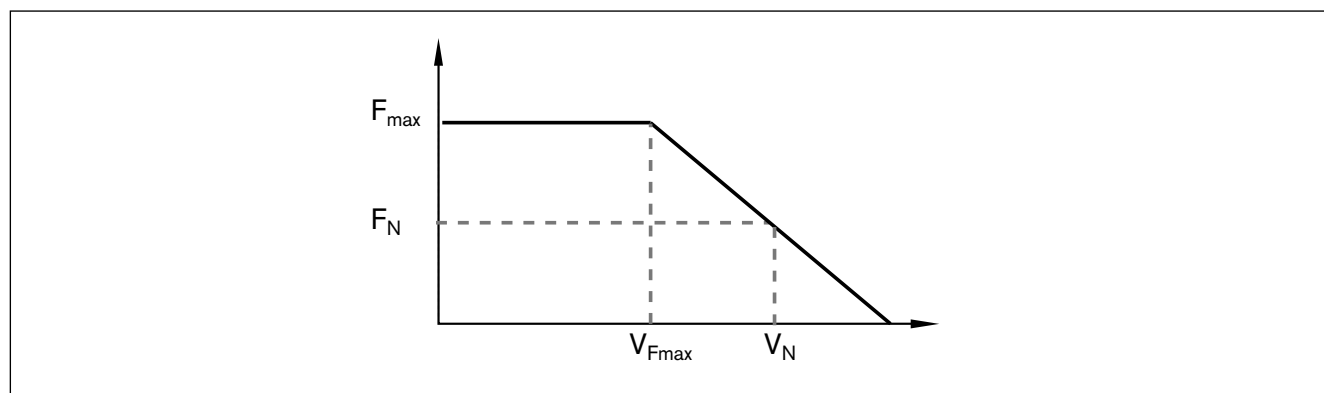

	Speed-dependent friction	Peak thrust ³⁾	Continuous nominal force ³⁾	Speed ⁴⁾ at F_{max}	Speed ⁴⁾ at F_N	Max. acceleration ⁶⁾
	(N)	F_{max} (N)	F_N (N)	v_{Fmax} (m/s)	v_N (m/s)	a_{max} (m/s ²)
	90	800	250	5.0	5.0 ⁵⁾	100
		1 150	370	4.1	5.0 ⁵⁾	
	125	2 000	550	5.0	5.0 ⁵⁾	
		2 600	820	4.1	5.0 ⁵⁾	
	160	3 750	1 180	3.1	4.8	
		5 600	1 785	4.1	5.0 ⁵⁾	
	220	7 150	2 310	3.1	4.8	

Motor dimensioning

Our design tool **IndraSize** is available for the exact dimensioning of the motor.

For further information on **IndraSize** and to download, go to: <http://www.boschrexroth.de/IndraSize>

Basic procedure:

The dimensioning or design of linear drives is largely determined by the application-dependent curves for speed and thrust force. The basic procedure for dimensioning linear drives is outlined in the following figures.

Define the speed profile

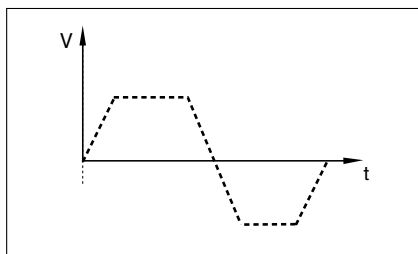

Determine the force progression

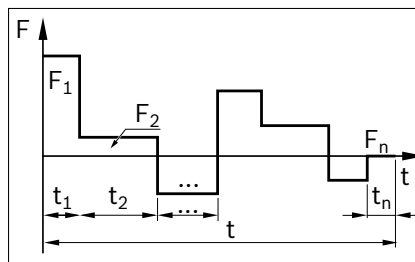

Compare the work points with torque/speed characteristic

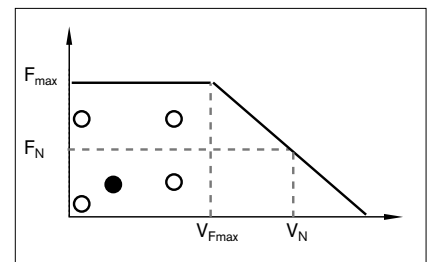

Effective motor force $F_{m\text{ eff}}$

$$F_{m\text{ eff}} = \sqrt{\frac{F_1^2 \cdot t_1 + F_2^2 \cdot t_2 + \dots + F_n^2 \cdot t_n}{t}}$$

$F_1, F_2 \dots F_n$ = motor force in phase 1 ... n (N)

$F_{m\text{ eff}}$ = effective force of motor (N)

t = time for all phases (s)

$t_1, t_2 \dots t_n$ = time for phase 1 ... n (s)

Further instructions are available in the documentation for the linear motor and the drive controller

Selection charts

These diagrams are only intended for a rough selection of the size and do not replace the necessary drive design.

The characteristics shown in the diagrams are determined based on the following parameters:

- Horizontal application
- The peak thrust is taken into account, not the continuous force!
- Liquid cooling

Payload 10 kg

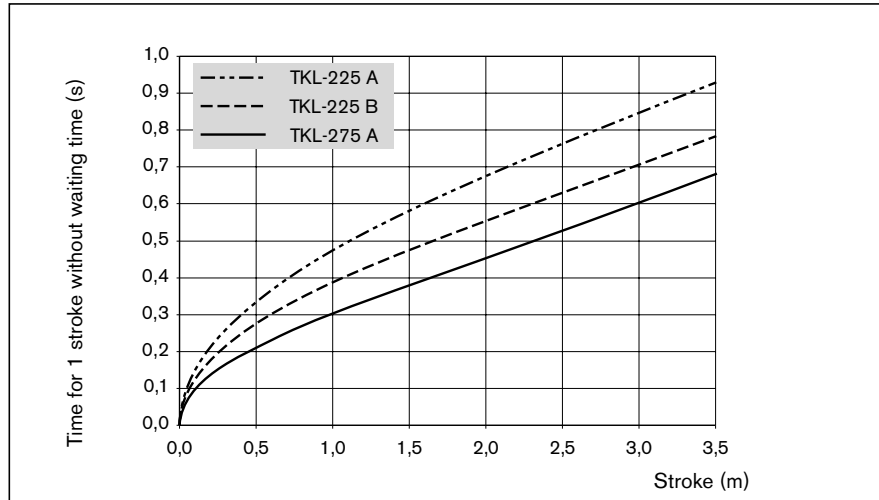

Payload 30 kg

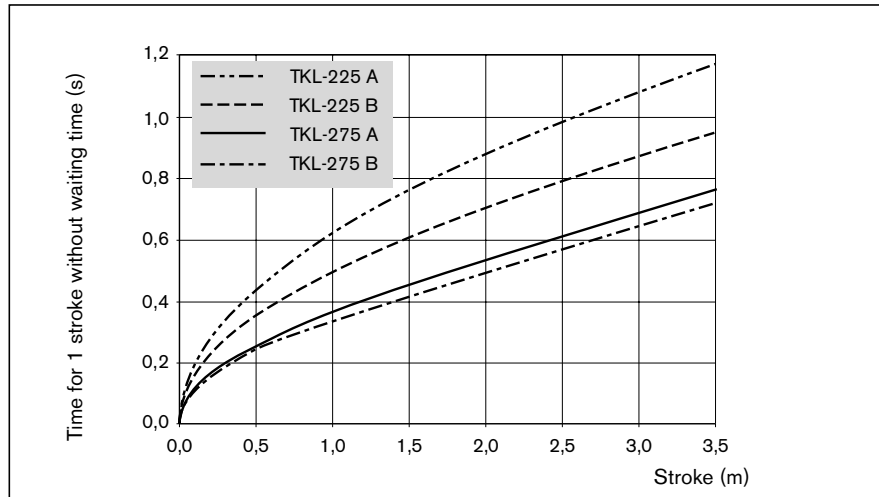

Payload 50 kg

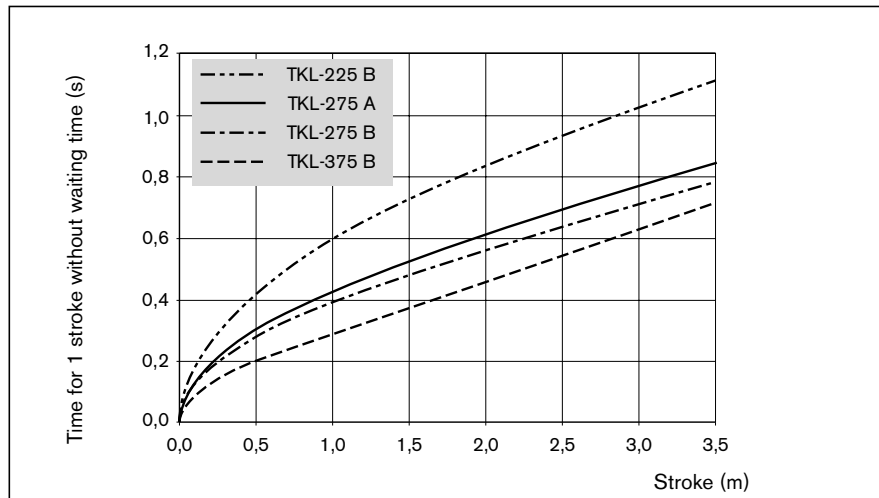

Payload 100 kg

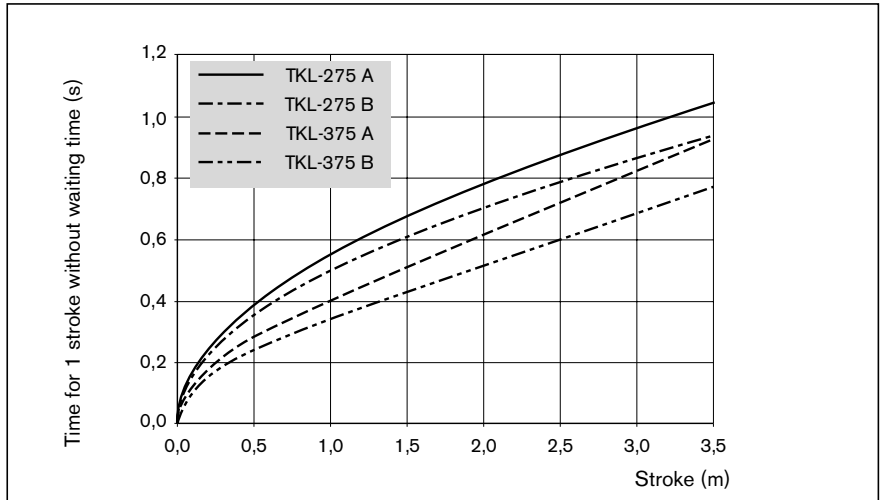

Payload 150 kg

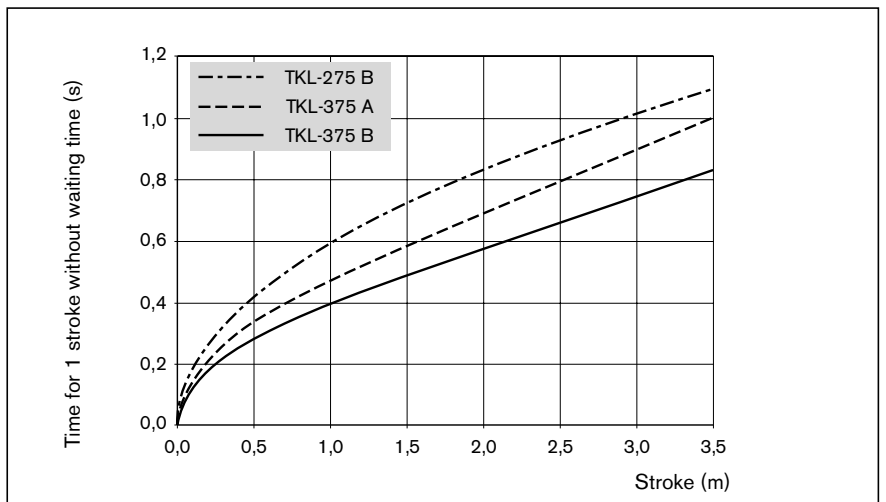

Payload 250 kg

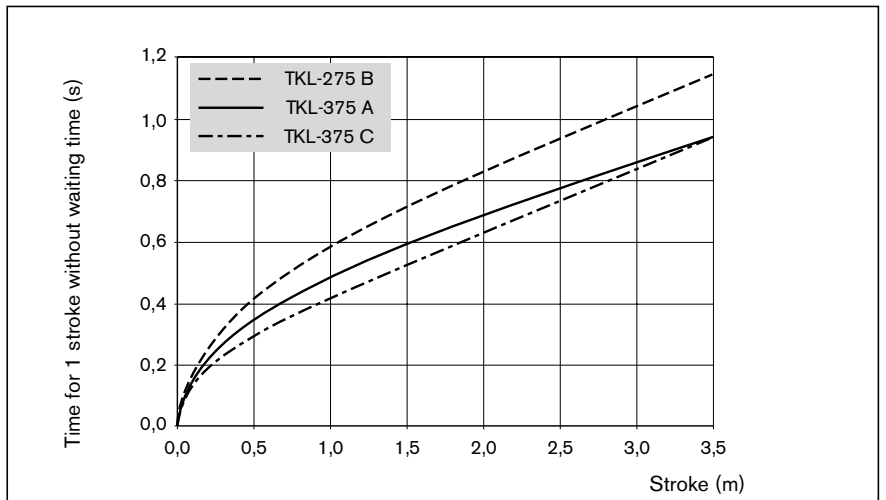

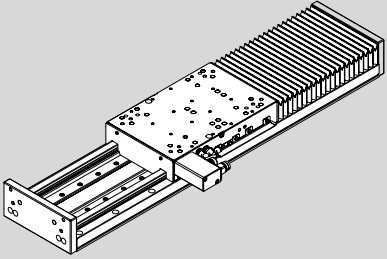
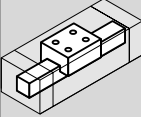
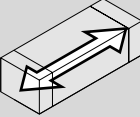
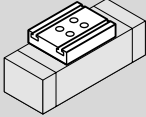
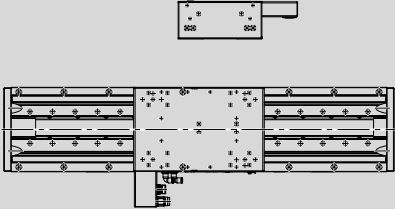

TKL-225

Configuration and ordering

Part number, length TKL-225-NN-2, ... mm 	Version	Type	Guideway 	Drive  Motor winding 250 300		Carriage  Ball Runner Blocks High Precision $V_{max} \leq 5 \text{ m/s}^1)$ Preload 8% C
with integrated measuring system 	IM01	Primary part A $L_{ca} = 340$	03	08		02
Primary part B $L_{ca} = 400$		03	17		12	

L_{ca} = carriage length
 NC = normally closed
 NO = normally open

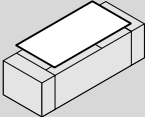
- 1) Other influencing factors with regard to the speed include:
Motor, supply voltage.
- 2) Recommended standard configuration: 2 proximity sensors (normally closed)
- 3) Switches are delivered as separate parts.
- 4) HIPERFACE® is a registered trademark of SICK STEGMANN GmbH.

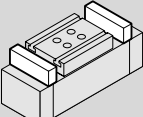
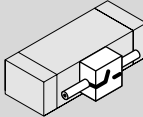
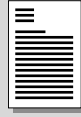
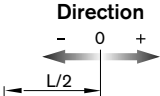
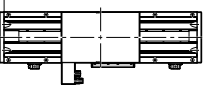
	Cover		Position measuring system	End position damping		Switching system ²⁾	Documentation	
	with	without		with cushioning	with cushioning/ with clamping unit		Standard report	Special report
								
		05	25	11	21	Without switch without switch 00 without switch tab 00 With proximity sensor³⁾ PNP - NC, plug M8 x 1 111 NPN - NC, plug M8 x 1 112 PNP - NO, plug M8 x 1 113 NPN - NO, plug M8 x 1 114 Switching cam 16 With mechanical switch³⁾ PNP - NC, plug M8 x 1 116 NPN - NC, plug M8 x 1 117 PNP - NO, plug M8 x 1 118 NPN - NO, plug M8 x 1 119 Switching cam 16 Cable duct without cable duct 00 with cable duct 20	01	02 Friction force
	01			12	22			04 Travel accuracy
		05	25	11	21	Direction  External switch 	01	05 Positioning accuracy
	01			12	22			

Travel distance: Effective travel distance = max. travel - 2 • excess travel

Switch activation point: Is the distance between the center of the base plate and the center of the carriage (specified in mm).
 Maximum switching distance = 0.5 • travel distance max. - excess travel

Excess travel: Excess travel must be greater than braking distance. To cushion the moved mass and reduce the excess travel, customers should install separate shock absorbers at the load center of gravity where required. The support is provided at the customer's site on the machine frame.

TKL-225 Dimension Drawing

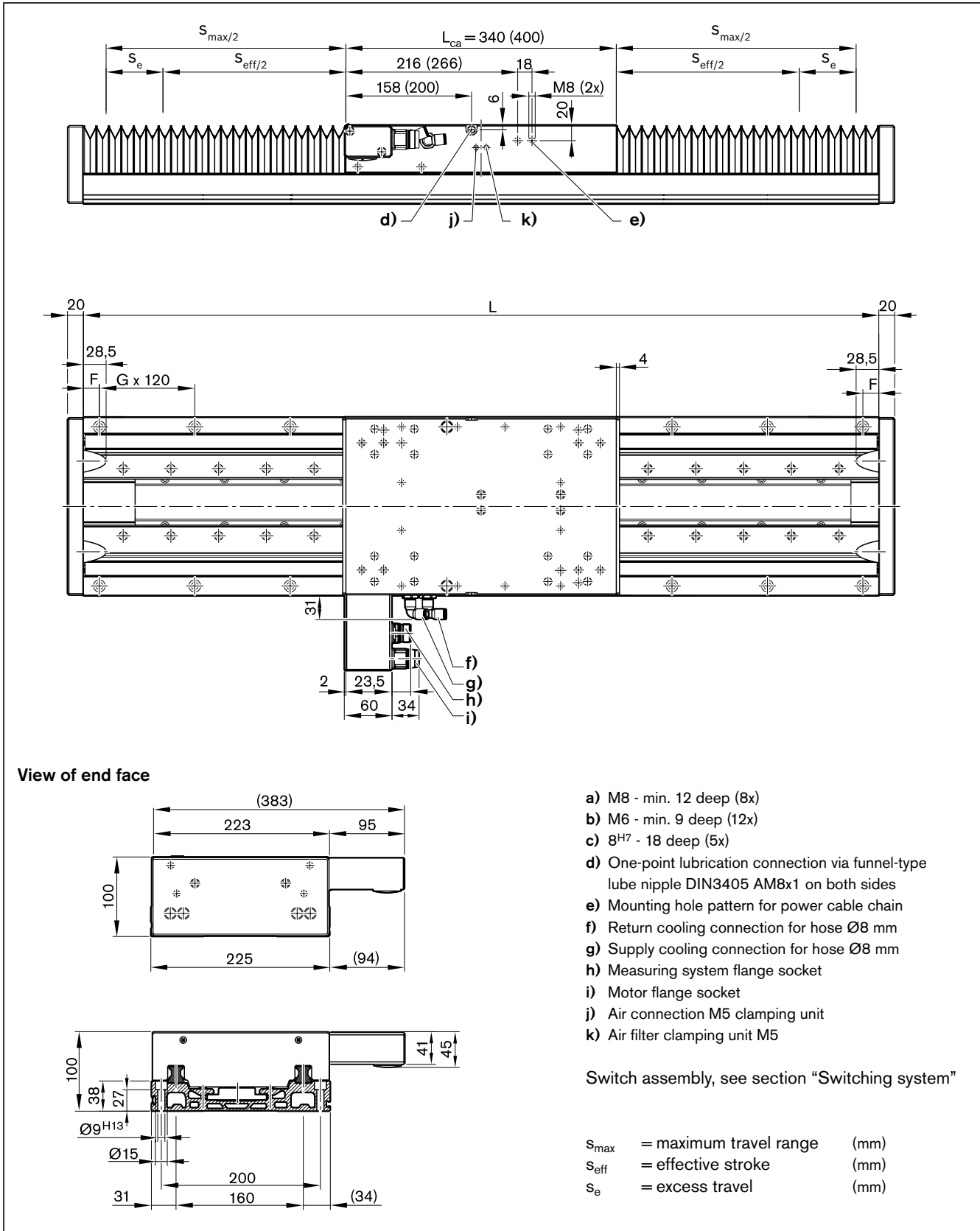

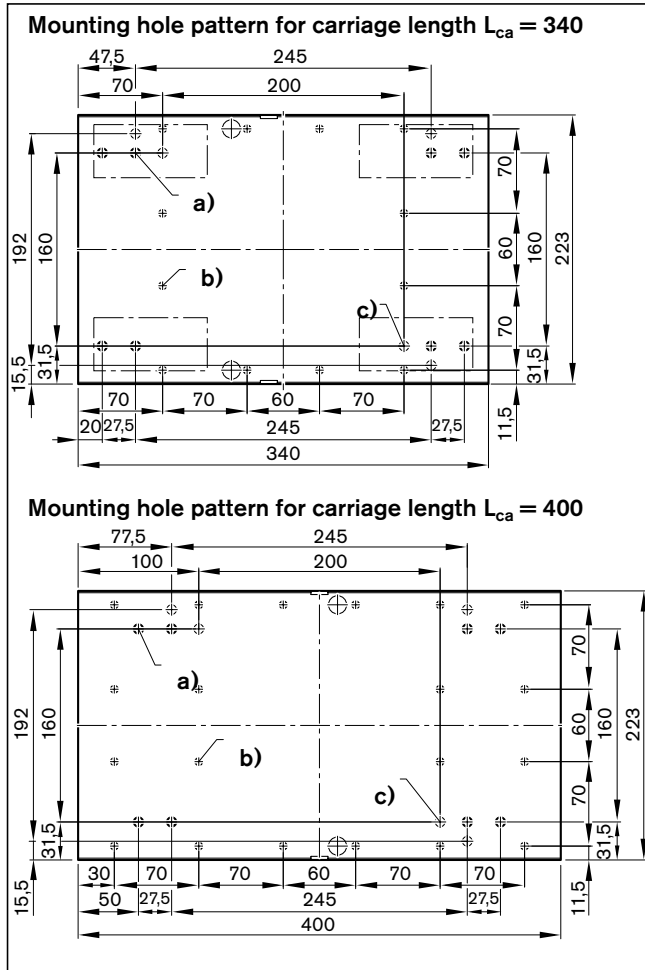

Length L (mm)	Counterbored mounting hole spacing			Max. travel (mm) for version			
				with bellows and carriage length L_{ca}		without bellows and carr. length L_{ca}	
	F	G x 120	F	340	400	340	400
1540	50	12 x 120	50	1006	954	1125	1065
1600	20	13 x 120	20	1058	1006	1185	1125
1660	50	13 x 120	50	1110	1058	1245	1185
1720	20	14 x 120	20	1162	1110	1305	1245
1780	50	14 x 120	50	1214	1162	1365	1305
1840	20	15 x 120	20	1266	1214	1425	1365
1900	50	15 x 120	50	1318	1266	1485	1425
1960	20	16 x 120	20	1370	1318	1545	1485
2020	50	16 x 120	50	1422	1370	1605	1545
2080	20	17 x 120	20	1474	1422	1665	1605
2140	50	17 x 120	50	1526	1474	1725	1665
2200	20	18 x 120	20	1578	1526	1785	1725
2260	50	18 x 120	50	1630	1578	1845	1785
2320	20	19 x 120	20	1682	1630	1905	1845
2380	50	19 x 120	50	1734	1682	1965	1905
2440	20	20 x 120	20	1786	1734	2025	1965
2500	50	20 x 120	50	1838	1786	2085	2025
2560	20	21 x 120	20	1890	1838	2145	2085
2620	50	21 x 120	50	1942	1890	2205	2145
2680	20	22 x 120	20	1994	1942	2265	2205
2740	50	22 x 120	50	2046	1994	2325	2265
2800	20	23 x 120	20	2098	2046	2385	2325
2860	50	23 x 120	50	2150	2098	2445	2385
2920	20	24 x 120	20	2202	2150	2505	2445
2980	50	24 x 120	50	2254	2202	2565	2505
3040	20	25 x 120	20	2306	2254	2625	2565
3100	50	25 x 120	50	2358	2306	2685	2625
3160	20	26 x 120	20	2410	2358	2745	2685
3220	50	26 x 120	50	2462	2410	2805	2745
3280	20	27 x 120	20	2513	2462	2865	2805
3340	50	27 x 120	50	2565	2513	2925	2865
3400	20	28 x 120	20	2617	2565	2985	2925
3460	50	28 x 120	50	2669	2617	3045	2985
3520	20	29 x 120	20	2721	2669	3105	3045
3580	50	29 x 120	50	2773	2721	3165	3105
3640	20	30 x 120	20	2825	2773	3225	3165
3700	50	30 x 120	50	2877	2825	3285	3225
3760	20	31 x 120	20	2929	2877	3345	3285
3820	50	31 x 120	50	2981	2929	3405	3345
3880	20	32 x 120	20	3033	2981	3465	3405
3940	50	32 x 120	50	3085	3033	3525	3465

Length L (mm)	Counterbored mounting hole spacing			Max. travel (mm) for version			
				with bellows and carriage length L_{ca}		without bellows and carr. length L_{ca}	
	F	G x 120	F	340	400	340	400
460	50	3 x 120	50	70	-	-	-
520	20	4 x 120	20	122	70	105	-
580	50	4 x 120	50	174	122	165	105
640	20	5 x 120	20	226	174	225	165
700	50	5 x 120	50	278	226	285	225
760	20	6 x 120	20	330	278	345	285
820	50	6 x 120	50	382	330	405	345
880	20	7 x 120	20	434	382	465	405
940	50	7 x 120	50	486	434	525	465
1000	20	8 x 120	20	538	486	585	525
1060	50	8 x 120	50	590	538	645	585
1120	20	9 x 120	20	642	590	705	645
1180	50	9 x 120	50	694	642	765	705
1240	20	10 x 120	20	746	694	825	765
1300	50	10 x 120	50	798	746	885	825
1360	20	11 x 120	20	850	798	945	885
1420	50	11 x 120	50	902	850	1005	945
1480	20	12 x 120	20	954	902	1065	1005



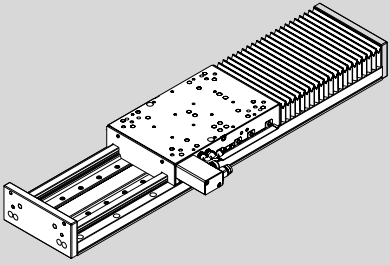
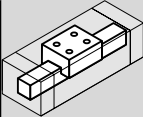
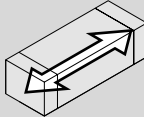
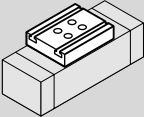
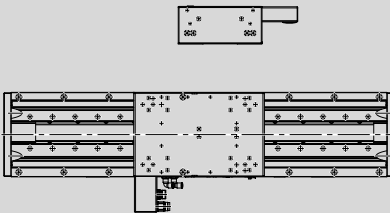

TKL-275

Configuration and ordering

Part number, length TKL-275-NN-2, ... mm 	Version	Type	Guideway 	Drive  Motor winding		Carriage  Ball Runner Blocks High Precision $V_{max} \leq 5 \text{ m/s}^1)$ Preload 8% C
with integrated measuring system 	IM01	Primary part A $L_{ca} = 395$	03	08		02
Primary part B $L_{ca} = 465$		03	17		12	

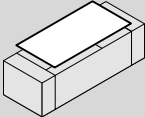
L_{ca} = carriage length
 NC = normally closed
 NO = normally open

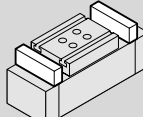
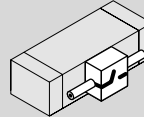
- 1) Other influencing factors with regard to the speed include:
Motor, supply voltage, measuring system etc.
- 2) Recommended standard configuration: 2 proximity sensors (normally closed)
- 3) Switches are delivered as separate parts.
- 4) HIPERFACE® is a registered trademark of SICK STEGMANN GmbH.

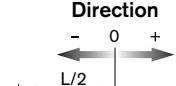
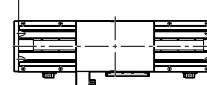
	Cover		Position measuring system	End position cushioning		Switching system ²⁾	Documentation																																					
	with	without		with cushioning	with cushioning/ with clamping unit		Standard report	Special report																																				
																																												
		05	25	11	21	<table border="1"> <tr><td colspan="2">Without switch</td></tr> <tr><td>without switch</td><td>00</td></tr> <tr><td>without switch tab</td><td>00</td></tr> <tr><td colspan="2">With proximity sensor³⁾</td></tr> <tr><td>PNP - NC, plug M8 x 1</td><td>111</td></tr> <tr><td>NPN - NC, plug M8 x 1</td><td>112</td></tr> <tr><td>PNP - NO, plug M8 x 1</td><td>113</td></tr> <tr><td>NPN - NO, plug M8 x 1</td><td>114</td></tr> <tr><td>Switching cam</td><td>16</td></tr> <tr><td colspan="2">With mechanical switch³⁾</td></tr> <tr><td>PNP - NC, plug M8 x 1</td><td>116</td></tr> <tr><td>NPN - NC, plug M8 x 1</td><td>117</td></tr> <tr><td>PNP - NO, plug M8 x 1</td><td>118</td></tr> <tr><td>NPN - NO, plug M8 x 1</td><td>119</td></tr> <tr><td>Switching cam</td><td>16</td></tr> <tr><td colspan="2">Cable duct</td></tr> <tr><td>without cable duct</td><td>00</td></tr> <tr><td>with cable duct</td><td>20</td></tr> </table>	Without switch		without switch	00	without switch tab	00	With proximity sensor³⁾		PNP - NC, plug M8 x 1	111	NPN - NC, plug M8 x 1	112	PNP - NO, plug M8 x 1	113	NPN - NO, plug M8 x 1	114	Switching cam	16	With mechanical switch³⁾		PNP - NC, plug M8 x 1	116	NPN - NC, plug M8 x 1	117	PNP - NO, plug M8 x 1	118	NPN - NO, plug M8 x 1	119	Switching cam	16	Cable duct		without cable duct	00	with cable duct	20	01	02 Friction force
Without switch																																												
without switch	00																																											
without switch tab	00																																											
With proximity sensor³⁾																																												
PNP - NC, plug M8 x 1	111																																											
NPN - NC, plug M8 x 1	112																																											
PNP - NO, plug M8 x 1	113																																											
NPN - NO, plug M8 x 1	114																																											
Switching cam	16																																											
With mechanical switch³⁾																																												
PNP - NC, plug M8 x 1	116																																											
NPN - NC, plug M8 x 1	117																																											
PNP - NO, plug M8 x 1	118																																											
NPN - NO, plug M8 x 1	119																																											
Switching cam	16																																											
Cable duct																																												
without cable duct	00																																											
with cable duct	20																																											
01		12	22	<table border="1"> <tr><td colspan="2">Without switch</td></tr> <tr><td>without switch</td><td>00</td></tr> <tr><td>without switch tab</td><td>00</td></tr> <tr><td colspan="2">With proximity sensor³⁾</td></tr> <tr><td>PNP - NC, plug M8 x 1</td><td>111</td></tr> <tr><td>NPN - NC, plug M8 x 1</td><td>112</td></tr> <tr><td>PNP - NO, plug M8 x 1</td><td>113</td></tr> <tr><td>NPN - NO, plug M8 x 1</td><td>114</td></tr> <tr><td>Switching cam</td><td>16</td></tr> <tr><td colspan="2">With mechanical switch³⁾</td></tr> <tr><td>PNP - NC, plug M8 x 1</td><td>116</td></tr> <tr><td>NPN - NC, plug M8 x 1</td><td>117</td></tr> <tr><td>PNP - NO, plug M8 x 1</td><td>118</td></tr> <tr><td>NPN - NO, plug M8 x 1</td><td>119</td></tr> <tr><td>Switching cam</td><td>16</td></tr> <tr><td colspan="2">Cable duct</td></tr> <tr><td>without cable duct</td><td>00</td></tr> <tr><td>with cable duct</td><td>20</td></tr> </table>	Without switch		without switch	00	without switch tab	00	With proximity sensor³⁾		PNP - NC, plug M8 x 1	111	NPN - NC, plug M8 x 1	112	PNP - NO, plug M8 x 1	113	NPN - NO, plug M8 x 1	114	Switching cam	16	With mechanical switch³⁾		PNP - NC, plug M8 x 1	116	NPN - NC, plug M8 x 1	117	PNP - NO, plug M8 x 1	118	NPN - NO, plug M8 x 1	119	Switching cam	16	Cable duct		without cable duct	00	with cable duct	20	04 Travel accuracy			
Without switch																																												
without switch	00																																											
without switch tab	00																																											
With proximity sensor³⁾																																												
PNP - NC, plug M8 x 1	111																																											
NPN - NC, plug M8 x 1	112																																											
PNP - NO, plug M8 x 1	113																																											
NPN - NO, plug M8 x 1	114																																											
Switching cam	16																																											
With mechanical switch³⁾																																												
PNP - NC, plug M8 x 1	116																																											
NPN - NC, plug M8 x 1	117																																											
PNP - NO, plug M8 x 1	118																																											
NPN - NO, plug M8 x 1	119																																											
Switching cam	16																																											
Cable duct																																												
without cable duct	00																																											
with cable duct	20																																											
		05	25	11	21	<table border="1"> <tr><td colspan="2">Without switch</td></tr> <tr><td>without switch</td><td>00</td></tr> <tr><td>without switch tab</td><td>00</td></tr> <tr><td colspan="2">With proximity sensor³⁾</td></tr> <tr><td>PNP - NC, plug M8 x 1</td><td>111</td></tr> <tr><td>NPN - NC, plug M8 x 1</td><td>112</td></tr> <tr><td>PNP - NO, plug M8 x 1</td><td>113</td></tr> <tr><td>NPN - NO, plug M8 x 1</td><td>114</td></tr> <tr><td>Switching cam</td><td>16</td></tr> <tr><td colspan="2">With mechanical switch³⁾</td></tr> <tr><td>PNP - NC, plug M8 x 1</td><td>116</td></tr> <tr><td>NPN - NC, plug M8 x 1</td><td>117</td></tr> <tr><td>PNP - NO, plug M8 x 1</td><td>118</td></tr> <tr><td>NPN - NO, plug M8 x 1</td><td>119</td></tr> <tr><td>Switching cam</td><td>16</td></tr> <tr><td colspan="2">Cable duct</td></tr> <tr><td>without cable duct</td><td>00</td></tr> <tr><td>with cable duct</td><td>20</td></tr> </table>	Without switch		without switch	00	without switch tab	00	With proximity sensor³⁾		PNP - NC, plug M8 x 1	111	NPN - NC, plug M8 x 1	112	PNP - NO, plug M8 x 1	113	NPN - NO, plug M8 x 1	114	Switching cam	16	With mechanical switch³⁾		PNP - NC, plug M8 x 1	116	NPN - NC, plug M8 x 1	117	PNP - NO, plug M8 x 1	118	NPN - NO, plug M8 x 1	119	Switching cam	16	Cable duct		without cable duct	00	with cable duct	20	01	05 Positioning accuracy
Without switch																																												
without switch	00																																											
without switch tab	00																																											
With proximity sensor³⁾																																												
PNP - NC, plug M8 x 1	111																																											
NPN - NC, plug M8 x 1	112																																											
PNP - NO, plug M8 x 1	113																																											
NPN - NO, plug M8 x 1	114																																											
Switching cam	16																																											
With mechanical switch³⁾																																												
PNP - NC, plug M8 x 1	116																																											
NPN - NC, plug M8 x 1	117																																											
PNP - NO, plug M8 x 1	118																																											
NPN - NO, plug M8 x 1	119																																											
Switching cam	16																																											
Cable duct																																												
without cable duct	00																																											
with cable duct	20																																											
01		12	22	<p>Direction</p>  <p>External switch</p> 																																								

Travel distance: Effective travel distance = max. travel - 2 • excess travel

Switch activation point: Is the distance between the center of the base plate and the center of the carriage (specified in mm).
Maximum switching distance = 0.5 • travel distance max. - excess travel

Excess travel: Excess travel must be greater than braking distance. To cushion the moved mass and reduce the excess travel, customers should install separate shock absorbers at the load center of gravity where required. The support is provided at the customer's site on the machine frame.

TKL-275 Dimension drawing

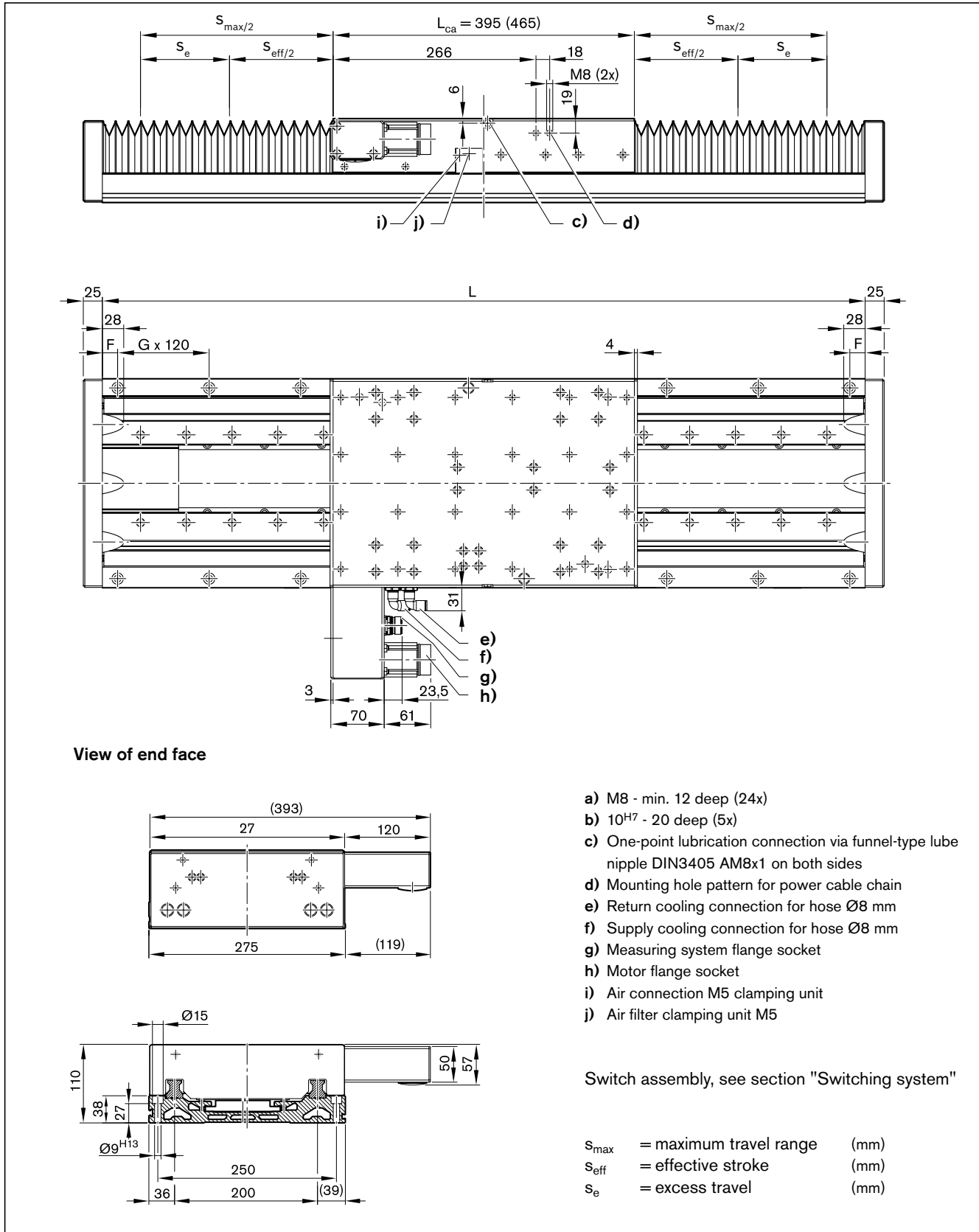

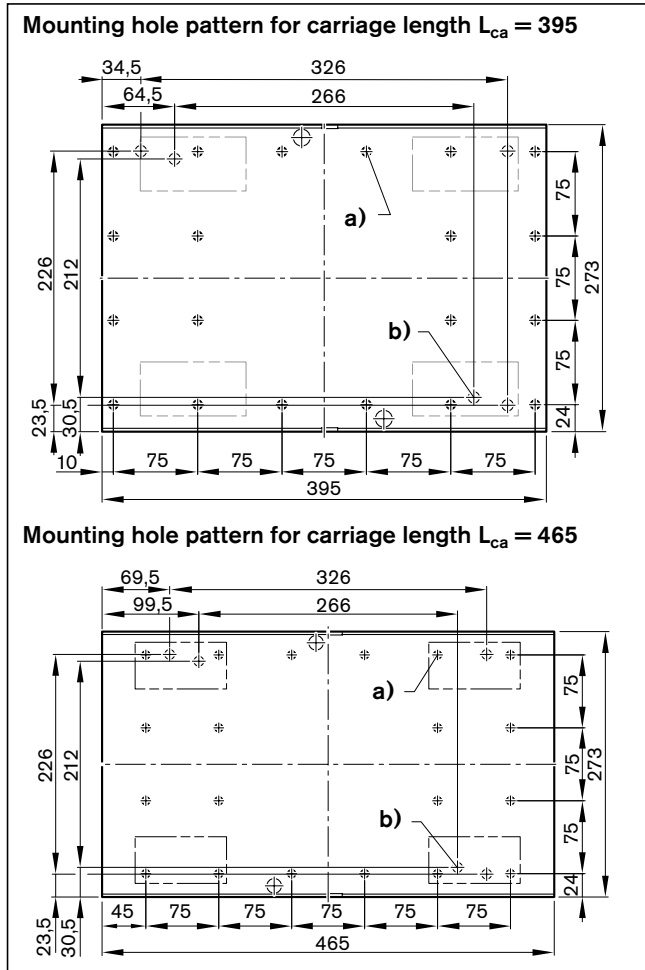

Length L (mm)	Counterbored mounting hole spacing			Max. travel (mm) for version			
	F	G x 120	F	with bellows and carr. length L_{ca}		without bellows and carr. length L_{ca}	
				395	465	395	465
1600	20	13 x 120	20	1026	964	1131	1061
1660	50	13 x 120	50	1079	1017	1191	1121
1720	20	14 x 120	20	1133	1071	1251	1181
1780	50	14 x 120	50	1186	1124	1311	1241
1840	20	15 x 120	20	1239	1177	1371	1301
1900	50	15 x 120	50	1292	1230	1431	1361
1960	20	16 x 120	20	1345	1283	1491	1421
2020	50	16 x 120	50	1399	1336	1551	1481
2080	20	17 x 120	20	1452	1390	1611	1541
2140	50	17 x 120	50	1505	1443	1671	1601
2200	20	18 x 120	20	1558	1496	1731	1661
2260	50	18 x 120	50	1611	1549	1791	1721
2320	20	19 x 120	20	1665	1602	1851	1781
2380	50	19 x 120	50	1718	1656	1911	1841
2440	20	20 x 120	20	1771	1709	1971	1901
2500	50	20 x 120	50	1824	1762	2031	1961
2560	20	21 x 120	20	1877	1815	2091	2021
2620	50	21 x 120	50	1930	1868	2151	2081
2680	20	22 x 120	20	1984	1922	2211	2141
2740	50	22 x 120	50	2037	1975	2271	2201
2800	20	23 x 120	20	2090	2028	2331	2261
2860	50	23 x 120	50	2143	2081	2391	2321
2920	20	24 x 120	20	2196	2134	2451	2381
2980	50	24 x 120	50	2250	2188	2511	2441
3040	20	25 x 120	20	2303	2241	2571	2501
3100	50	25 x 120	50	2356	2294	2631	2561
3160	20	26 x 120	20	2409	2347	2691	2621
3220	50	26 x 120	50	2462	2400	2751	2681
3280	20	27 x 120	20	2516	2454	2811	2741
3340	50	27 x 120	50	2569	2507	2871	2801
3400	20	28 x 120	20	2622	2560	2931	2861
3460	50	28 x 120	50	2675	2613	2991	2921
3520	20	29 x 120	20	2728	2666	3051	2981
3580	50	29 x 120	50	2782	2719	3111	3041
3640	20	30 x 120	20	2835	2773	3171	3101
3700	50	30 x 120	50	2888	2826	3231	3161
3760	20	31 x 120	20	2941	2879	3291	3221
3820	50	31 x 120	50	2994	2932	3351	3281
3880	20	32 x 120	20	3047	2985	3411	3341
3940	50	32 x 120	50	3101	3039	3471	3401

Length L (mm)	Counterbored mounting hole spacing			Max. travel (mm) for version			
	F	G x 120	F	with bellows and carr. length L_{ca}		without bellows and carr. length L_{ca}	
				395	465	395	465
580	50	4 x 120	50	122	-	111	-
640	20	5 x 120	20	175	113	171	101
700	50	5 x 120	50	228	166	231	161
760	20	6 x 120	20	282	219	291	221
820	50	6 x 120	50	335	273	351	281
880	20	7 x 120	20	388	326	411	341
940	50	7 x 120	50	441	379	471	401
1000	20	8 x 120	20	494	432	531	461
1060	50	8 x 120	50	547	485	591	521
1120	20	9 x 120	20	601	539	651	581
1180	50	9 x 120	50	654	592	711	641
1240	20	10 x 120	20	707	645	771	701
1300	50	10 x 120	50	760	698	831	761
1360	20	11 x 120	20	813	751	891	821
1420	50	11 x 120	50	867	805	951	881
1480	20	12 x 120	20	920	858	1011	941
1540	50	12 x 120	50	973	911	1071	1001



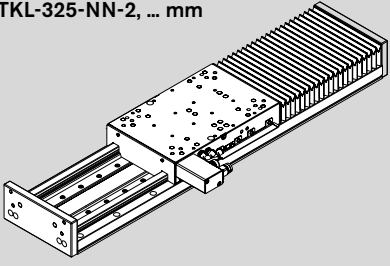
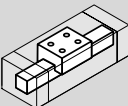
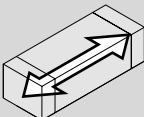
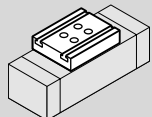
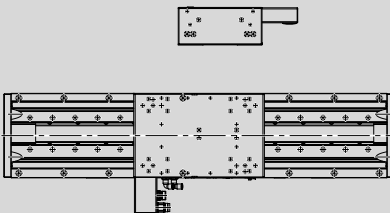

TKL-325

Configuration and ordering

Part number, length TKL-325-NN-2, ... mm 	Version	Type	Guideway 	Drive  Motor winding 190 250		Carriage  Ball Runner Blocks High Precision $V_{max} \leq 5 \text{ m/s}^{1)}$ Preload 8% C
with integrated measuring system 		Primary part A $L_{ca} = 475$	03	06		02
	IM01	Primary part B $L_{ca} = 625$	03		17	12
		Primary part C $L_{ca} = 775$	03	26		22

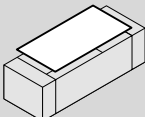
L_{ca} = carriage length
 NC = normally closed
 NO = normally open

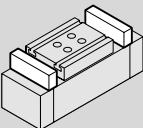
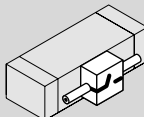
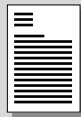
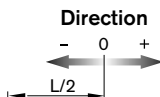
- 1) Other influencing factors with regard to the speed include:
 Motor, supply voltage, measuring system etc.
- 2) Recommended standard configuration: 2 proximity sensors
 (normally closed)
- 3) Switches are delivered as separate parts.
- 4) HIPERFACE® is a registered trademark of SICK STEGMANN GmbH.

Cover		Position measuring system	End position damping		Switching system ²⁾	Documentation																																					
																																											
with	without	Integrated Measuring System Absolute IMS-A (Hiperface ⁴⁾)	with cushioning	with cushioning/with clamping unit	<table border="1"> <tr> <td colspan="2">Without switch</td> </tr> <tr> <td>without switch</td> <td>00</td> </tr> <tr> <td>without switch tab</td> <td>00</td> </tr> <tr> <td colspan="2">With proximity sensor³⁾</td> </tr> <tr> <td>PNP - NC, plug M8 x 1</td> <td>111</td> </tr> <tr> <td>NPN - NC, plug M8 x 1</td> <td>112</td> </tr> <tr> <td>PNP - NO, plug M8 x 1</td> <td>113</td> </tr> <tr> <td>NPN - NO, plug M8 x 1</td> <td>114</td> </tr> <tr> <td>Switching cam</td> <td>16</td> </tr> <tr> <td colspan="2">With mechanical switch³⁾</td> </tr> <tr> <td>PNP - NC, plug M8 x 1</td> <td>116</td> </tr> <tr> <td>NPN - NC, plug M8 x 1</td> <td>117</td> </tr> <tr> <td>PNP - NO, plug M8 x 1</td> <td>118</td> </tr> <tr> <td>NPN - NO, plug M8 x 1</td> <td>119</td> </tr> <tr> <td>Switching cam</td> <td>16</td> </tr> <tr> <td colspan="2">Cable duct</td> </tr> <tr> <td>without cable duct</td> <td>00</td> </tr> <tr> <td>with cable duct</td> <td>20</td> </tr> </table>	Without switch		without switch	00	without switch tab	00	With proximity sensor³⁾		PNP - NC, plug M8 x 1	111	NPN - NC, plug M8 x 1	112	PNP - NO, plug M8 x 1	113	NPN - NO, plug M8 x 1	114	Switching cam	16	With mechanical switch³⁾		PNP - NC, plug M8 x 1	116	NPN - NC, plug M8 x 1	117	PNP - NO, plug M8 x 1	118	NPN - NO, plug M8 x 1	119	Switching cam	16	Cable duct		without cable duct	00	with cable duct	20	Standard report	Special report
Without switch																																											
without switch	00																																										
without switch tab	00																																										
With proximity sensor³⁾																																											
PNP - NC, plug M8 x 1	111																																										
NPN - NC, plug M8 x 1	112																																										
PNP - NO, plug M8 x 1	113																																										
NPN - NO, plug M8 x 1	114																																										
Switching cam	16																																										
With mechanical switch³⁾																																											
PNP - NC, plug M8 x 1	116																																										
NPN - NC, plug M8 x 1	117																																										
PNP - NO, plug M8 x 1	118																																										
NPN - NO, plug M8 x 1	119																																										
Switching cam	16																																										
Cable duct																																											
without cable duct	00																																										
with cable duct	20																																										
	05	25	11	21	<table border="1"> <tr> <td colspan="2">Without switch</td> </tr> <tr> <td>without switch</td> <td>00</td> </tr> <tr> <td>without switch tab</td> <td>00</td> </tr> <tr> <td colspan="2">With proximity sensor³⁾</td> </tr> <tr> <td>PNP - NC, plug M8 x 1</td> <td>111</td> </tr> <tr> <td>NPN - NC, plug M8 x 1</td> <td>112</td> </tr> <tr> <td>PNP - NO, plug M8 x 1</td> <td>113</td> </tr> <tr> <td>NPN - NO, plug M8 x 1</td> <td>114</td> </tr> <tr> <td>Switching cam</td> <td>16</td> </tr> <tr> <td colspan="2">With mechanical switch³⁾</td> </tr> <tr> <td>PNP - NC, plug M8 x 1</td> <td>116</td> </tr> <tr> <td>NPN - NC, plug M8 x 1</td> <td>117</td> </tr> <tr> <td>PNP - NO, plug M8 x 1</td> <td>118</td> </tr> <tr> <td>NPN - NO, plug M8 x 1</td> <td>119</td> </tr> <tr> <td>Switching cam</td> <td>16</td> </tr> <tr> <td colspan="2">Cable duct</td> </tr> <tr> <td>without cable duct</td> <td>00</td> </tr> <tr> <td>with cable duct</td> <td>20</td> </tr> </table>	Without switch		without switch	00	without switch tab	00	With proximity sensor³⁾		PNP - NC, plug M8 x 1	111	NPN - NC, plug M8 x 1	112	PNP - NO, plug M8 x 1	113	NPN - NO, plug M8 x 1	114	Switching cam	16	With mechanical switch³⁾		PNP - NC, plug M8 x 1	116	NPN - NC, plug M8 x 1	117	PNP - NO, plug M8 x 1	118	NPN - NO, plug M8 x 1	119	Switching cam	16	Cable duct		without cable duct	00	with cable duct	20	01	02 Friction force
Without switch																																											
without switch	00																																										
without switch tab	00																																										
With proximity sensor³⁾																																											
PNP - NC, plug M8 x 1	111																																										
NPN - NC, plug M8 x 1	112																																										
PNP - NO, plug M8 x 1	113																																										
NPN - NO, plug M8 x 1	114																																										
Switching cam	16																																										
With mechanical switch³⁾																																											
PNP - NC, plug M8 x 1	116																																										
NPN - NC, plug M8 x 1	117																																										
PNP - NO, plug M8 x 1	118																																										
NPN - NO, plug M8 x 1	119																																										
Switching cam	16																																										
Cable duct																																											
without cable duct	00																																										
with cable duct	20																																										
01		12	22	04 Travel accuracy																																							
01		25	11	21	<table border="1"> <tr> <td colspan="2">Without switch</td> </tr> <tr> <td>without switch</td> <td>00</td> </tr> <tr> <td>without switch tab</td> <td>00</td> </tr> <tr> <td colspan="2">With proximity sensor³⁾</td> </tr> <tr> <td>PNP - NC, plug M8 x 1</td> <td>111</td> </tr> <tr> <td>NPN - NC, plug M8 x 1</td> <td>112</td> </tr> <tr> <td>PNP - NO, plug M8 x 1</td> <td>113</td> </tr> <tr> <td>NPN - NO, plug M8 x 1</td> <td>114</td> </tr> <tr> <td>Switching cam</td> <td>16</td> </tr> <tr> <td colspan="2">With mechanical switch³⁾</td> </tr> <tr> <td>PNP - NC, plug M8 x 1</td> <td>116</td> </tr> <tr> <td>NPN - NC, plug M8 x 1</td> <td>117</td> </tr> <tr> <td>PNP - NO, plug M8 x 1</td> <td>118</td> </tr> <tr> <td>NPN - NO, plug M8 x 1</td> <td>119</td> </tr> <tr> <td>Switching cam</td> <td>16</td> </tr> <tr> <td colspan="2">Cable duct</td> </tr> <tr> <td>without cable duct</td> <td>00</td> </tr> <tr> <td>with cable duct</td> <td>20</td> </tr> </table>	Without switch		without switch	00	without switch tab	00	With proximity sensor³⁾		PNP - NC, plug M8 x 1	111	NPN - NC, plug M8 x 1	112	PNP - NO, plug M8 x 1	113	NPN - NO, plug M8 x 1	114	Switching cam	16	With mechanical switch³⁾		PNP - NC, plug M8 x 1	116	NPN - NC, plug M8 x 1	117	PNP - NO, plug M8 x 1	118	NPN - NO, plug M8 x 1	119	Switching cam	16	Cable duct		without cable duct	00	with cable duct	20	01	05 Positioning accuracy
Without switch																																											
without switch	00																																										
without switch tab	00																																										
With proximity sensor³⁾																																											
PNP - NC, plug M8 x 1	111																																										
NPN - NC, plug M8 x 1	112																																										
PNP - NO, plug M8 x 1	113																																										
NPN - NO, plug M8 x 1	114																																										
Switching cam	16																																										
With mechanical switch³⁾																																											
PNP - NC, plug M8 x 1	116																																										
NPN - NC, plug M8 x 1	117																																										
PNP - NO, plug M8 x 1	118																																										
NPN - NO, plug M8 x 1	119																																										
Switching cam	16																																										
Cable duct																																											
without cable duct	00																																										
with cable duct	20																																										
	05	12	22																																								
01		25	11	21	<p>Direction</p>  <p>External switch</p> 	01	05 Positioning accuracy																																				
	05		12	22																																							

Travel distance: Effective travel distance = max. travel - 2 • excess travel

Switch activation point: Is the distance between the center of the base plate and the center of the carriage (specified in mm). Maximum switching distance = 0.5 • travel distance max. - excess travel

Excess travel: Excess travel must be greater than braking distance. To cushion the moved mass and reduce the excess travel, customers should install separate shock absorbers at the load center of gravity where required. The support is provided at the customer's site on the machine frame.

TKL-325 Dimension drawing

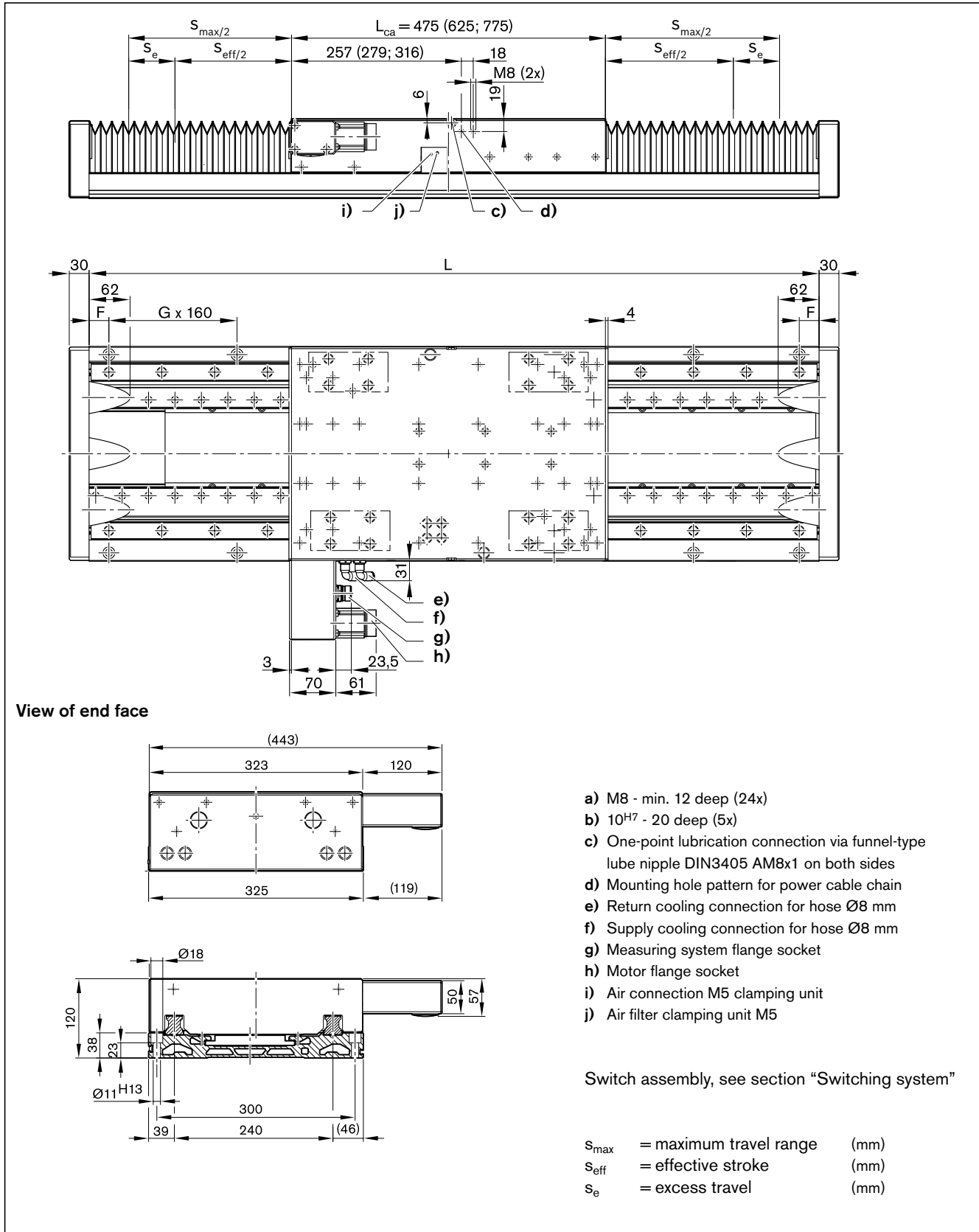

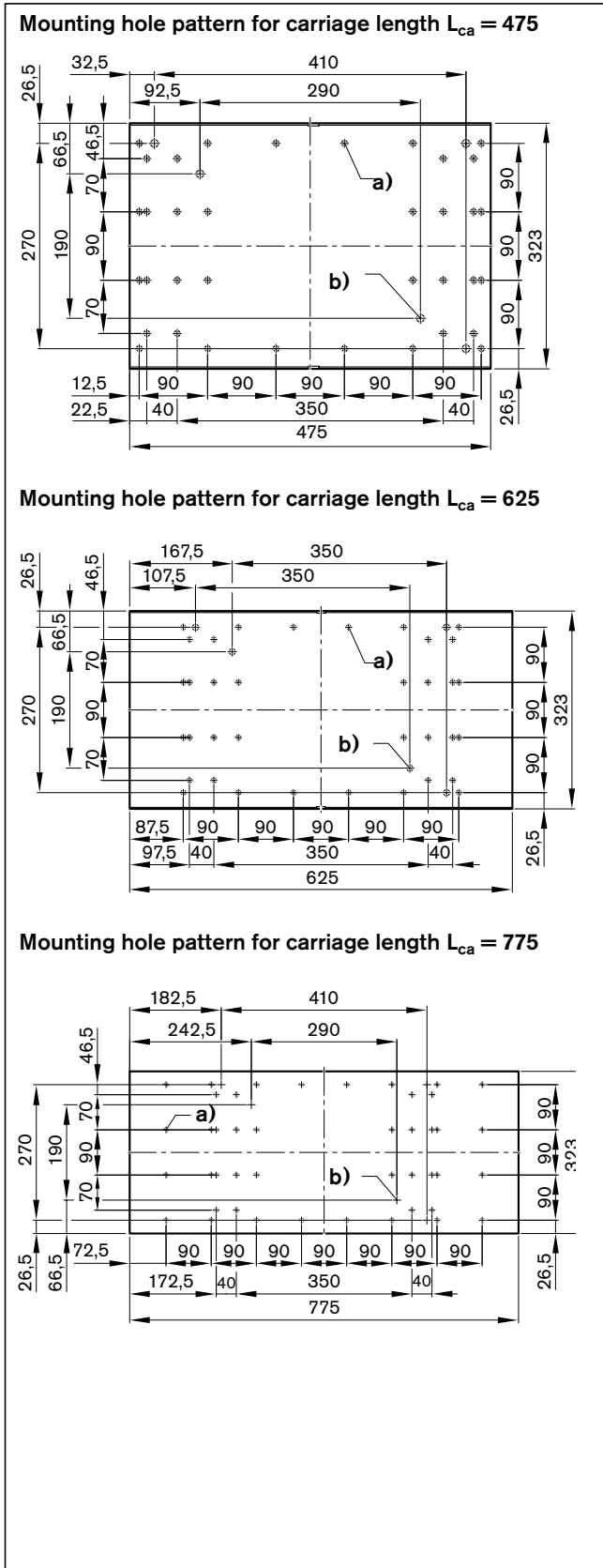

Length L (mm)	Counterbored mounting hole spacing			Max. travel (mm) for version					
	F	G	x 160 F	with bellows and carriage length L_{ca}			without bellows and carriage length L_{ca}		
				475	625	775	475	625	775
700	30	4	x 160 30	157	-	-	-	-	-
780	70	4	x 160 70	228	-	-	163	-	-
860	30	5	x 160 30	299	166	-	243	-	-
940	70	5	x 160 70	370	237	-	323	173	-
1020	30	6	x 160 30	441	308	175	403	253	-
1100	70	6	x 160 70	512	379	246	483	333	183
1180	30	7	x 160 30	583	450	317	563	413	263
1260	70	7	x 160 70	654	521	388	643	493	343
1340	30	8	x 160 30	725	592	459	723	573	423
1420	70	8	x 160 70	796	663	530	803	653	503
1500	30	9	x 160 30	867	734	601	883	733	583
1580	70	9	x 160 70	938	805	672	963	813	663
1660	30	10	x 160 30	1008	875	743	1043	893	743
1740	70	10	x 160 70	1079	946	813	1123	973	823
1820	30	11	x 160 30	1150	1017	884	1203	1053	903
1900	70	11	x 160 70	1221	1088	955	1283	1133	983
1980	30	12	x 160 30	1292	1159	1026	1363	1213	1063
2060	70	12	x 160 70	1363	1230	1097	1443	1293	1143
2140	30	13	x 160 30	1434	1301	1168	1523	1373	1223
2220	70	13	x 160 70	1505	1372	1239	1603	1453	1303
2300	30	14	x 160 30	1576	1443	1310	1683	1533	1383
2380	70	14	x 160 70	1647	1514	1381	1763	1613	1463
2460	30	15	x 160 30	1718	1585	1452	1843	1693	1543
2540	70	15	x 160 70	1789	1656	1523	1923	1773	1623
2620	30	16	x 160 30	1860	1727	1594	2003	1853	1703
2700	70	16	x 160 70	1930	1797	1665	2083	1933	1783
2780	30	17	x 160 30	2001	1868	1735	2163	2013	1863
2860	70	17	x 160 70	2072	1939	1806	2243	2093	1943
2940	30	18	x 160 30	2143	2010	1877	2323	2173	2023
3020	70	18	x 160 70	2214	2081	1948	2403	2253	2103
3100	30	19	x 160 30	2285	2152	2019	2483	2333	2183
3180	70	19	x 160 70	2356	2223	2090	2563	2413	2263
3260	30	20	x 160 30	2427	2294	2161	2643	2493	2343
3340	70	20	x 160 70	2498	2365	2232	2723	2573	2423
3420	30	21	x 160 30	2569	2436	2303	2803	2653	2503
3500	70	21	x 160 70	2640	2507	2374	2883	2733	2583
3580	30	22	x 160 30	2711	2578	2445	2963	2813	2663
3660	70	22	x 160 70	2782	2649	2516	3043	2893	2743
3740	30	23	x 160 30	2852	2719	2586	3123	2973	2823
3820	70	23	x 160 70	2923	2790	2657	3203	3053	2903
3900	30	24	x 160 30	2994	2861	2728	3283	3133	2983
3980	70	24	x 160 70	3065	2932	2799	3363	3213	3063

Linear motor

Description

The drive-related key component of the Ball Rail Table TKL is the iron-core Linear Motor MLF.

The thrust with the synchronous linear motor is generated in the same way as the torque is generated on rotary synchronous motors.

The primary part (active part) carries a three-phase winding, the secondary part (passive part) carries permanent magnets. Two Ball Rail Systems support and guide the primary part and its load. The secondary parts are mounted on the base plate.

The primary part and the secondary part do not come into contact with each other.

The forces and torques originating from the payload are transferred exclusively to the Ball Rail System.

Unlike rotary drive systems, the linear motor comprises no internal moving parts and is consequently low-wearing and low-maintenance. It also eliminates the need for additional rotary-to-linear conversion mechanisms.

Due to the associated high static and dynamic load rigidity, the control accuracy and positioning behavior over the entire drive service life is unrivaled.

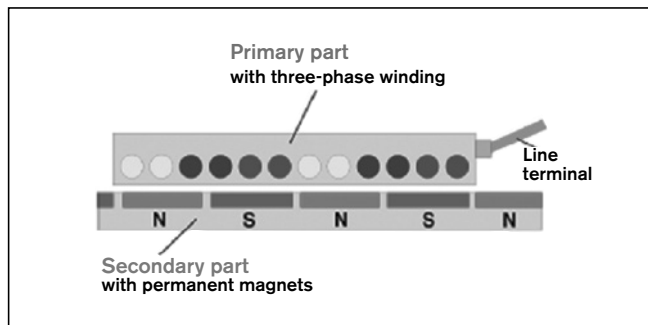
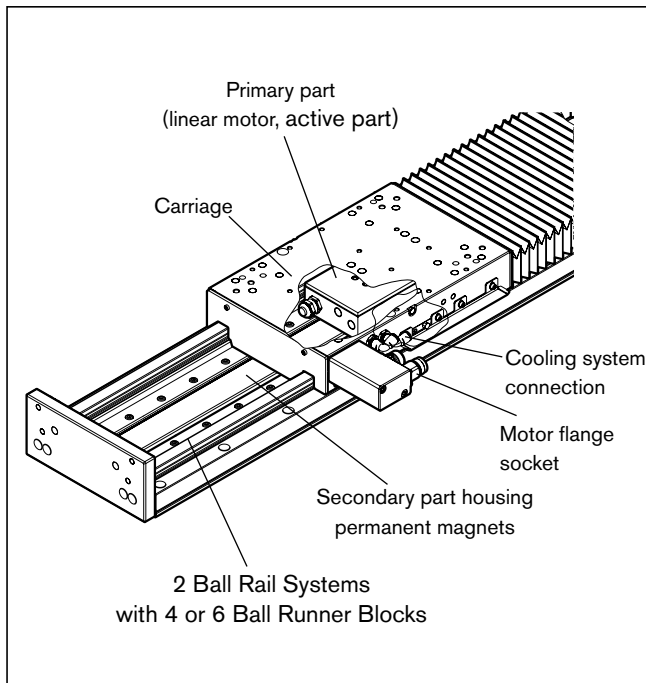

The linear direct drive technology is an optimal alternative in many cases and offers distinct advantages:

- High speed and acceleration
- Outstanding control accuracy and positioning behavior
- Direct force generation - no mechanical transfer elements (like a ball screw drive, toothed belt, toothed rack etc.)
- Low-maintenance drive (no wearing parts on the motor)
- Compact machine design
- High static and dynamic load rigidity

Motor flange socket pin assignment

Pin no.	
U1	A1
V1	A2
W1	A3
4	PE
5 ¹⁾	SNM 150 DK +
6 ¹⁾	SNM 150 DK -
7	n.c.
8	n.c.
9	n.c.

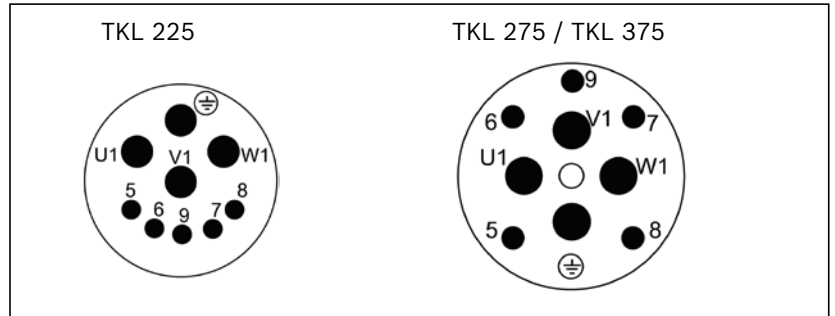

1) Motor temperature monitoring:

The primary parts are equipped with integrated temperature sensors for motor protection as standard.

Each motor phase contains one of three ceramic resistors (PTC) connected in series to enable thermal monitoring of the motor in all operating phases. These temperature sensors have a switching characteristic and are evaluated on all Rexroth drive control devices.

Motor flange socket technical data

Plug size	M23	M40
Enclosure	IP67	
Contact type	Pins	
Rated voltage	630 V/125 V	
Rated current	23 A	57 A
Degree of contamination	3	
Overvoltage category	III (DIN VDE 0110)	
Corresponding wiring box	RLS1101	RLS1201

Cooling circuit connection

- Connect the cooling circuit on the carriage of the TKL
- Maximum pressure +10 bar must be observed
- The cooling lubricant inlet temperature must be max. 5 K below the ambient temperature.
- Only use suitable coolant additives (e. g. Aquaplus 22 / Petrofer)
- Observe the documentation for the motor and cooling unit

 Further instructions are available in the documentation for the linear motor

Position measuring system

Description

The key measurement component of the Ball Rail Table TKL is the Integrated Absolute Measuring System (IMS-A) from Rexroth. Integrating the measuring technology into the linear guide results in a mechatronic system which combines the ability to guide mechanical loads and to measure length in one product.

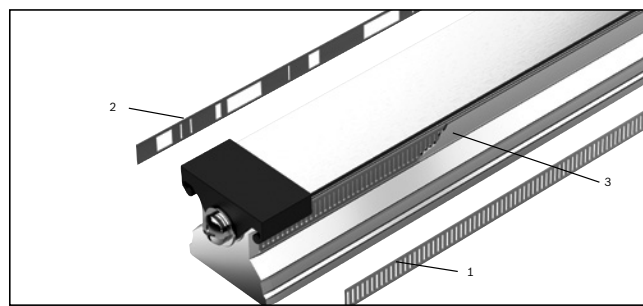
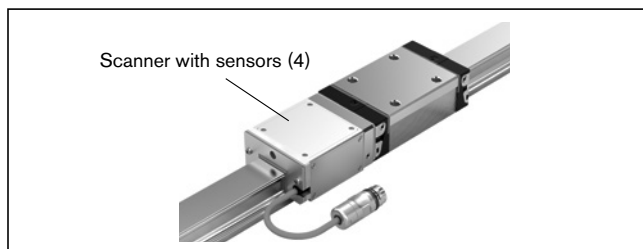
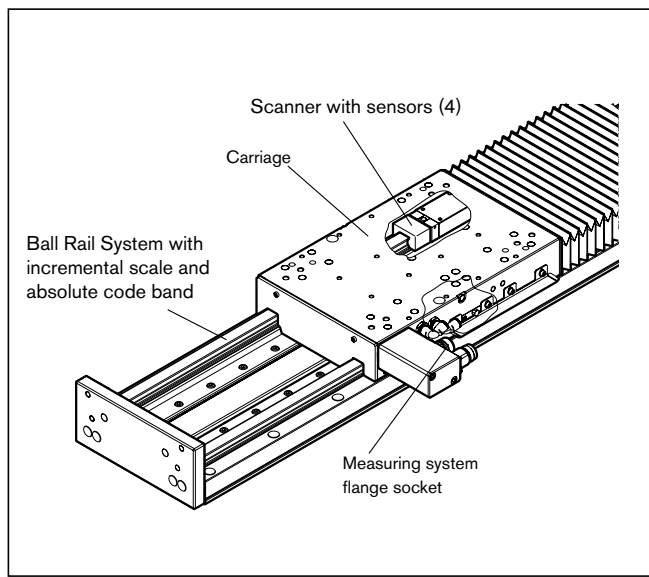

The Integrated Absolute Measuring System (IMS-A) consists of the scanner (4), the incremental scale (1) and the absolute code band (2). The scanner with sensors is mounted on the Runner Block.

As it travels over them, it evaluates the incremental scale and the absolute code band integrated in the rail.

The scales are protected by a hermetically sealed welded stainless steel band (3).

Highlights

- ▶ The guide and measuring system form a unit
- ▶ No additional space required
- ▶ No measuring inaccuracies due to deviations in parallelism between the measuring system and the guideway
- ▶ Position measurement directly at the workpiece/tool
- ▶ Protection class IP67 (only for the measuring system)
- ▶ The inductive measuring principle allows for non-contact measurement
- ▶ Contact-free scanning ensures zero maintenance
- ▶ Insusceptible to magnetic fields
- ▶ High resolution thanks to 40 μm signal period
- ▶ Precise, absolute positioning by an additional absolute code band
- ▶ No battery necessary for buffering the absolute information

Measuring system flange socket pin assignment

Pin no.	Signal assignment	Function
1	Inner shield	Inner cable shield
2	A +	Analog/digital path information
3	A -	
4	GND	Power supply GND
5	B +	Analog/digital path information
6	B -	
7	Data +	IMS-A: HIPERFACE®
8	Data -	
9	n.c.	
10	n.c.	
11	VDD	Power supply VDD
12	n.c.	
13	n.c.	
14	n.c.	
15	0 V Sense	Sense line* GND
16	5 V Sense	Sense line* VDD
17	n.c.	
Housing	Outer shield	Outer shield contacted via connector housing

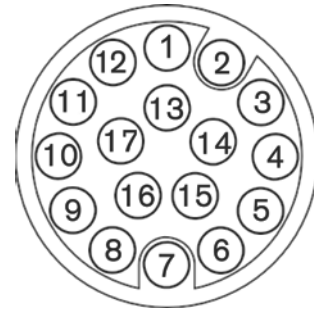
**Technical data measuring system flange socket**

Plug size	M17
Enclosure	IP67
Contact type	Pins
Rated voltage	60 V
Rated current	3.6 A
Degree of contamination	3
Overvoltage category	III
Corresponding wiring box	RGS1711

Accuracy IMS-A

Accuracy class scale ($\mu\text{m}/\text{m}$)	± 5
Interpolation accuracy scanner (μm)	± 0.75
Repeatability scanner (μm)	± 0.25

Interface IMS-A

Signal	HIPERFACE ¹⁾
Resolution of the digital interface (μm)	1.25
Dissolvability of the 1 V_{SS} / 40 μm signal (μm)	0.025

1) HIPERFACE® is a registered trademark of SICK STEGMANN GmbH.

 Further instructions are available in the documentation for the Integrated Measuring System

Clamping unit

Carriage with clamping unit

On carriages with an integrated clamping unit, the air ports are located on the longitudinal side of the carriage.

Clamping unit (MKS)

The clamping unit is used exclusively for clamping linear axes (static holding)

Owing to the spring energy accumulator, it is closed in the deenergized condition (NC).

The clamping unit is usable as a proven component in connection with a suitable function test and in category 1 controls as per DIN EN ISO 13849-1:2006.

For further instructions and information, please refer to the documentation for this product (clamping unit MKS).

⚠ The clamping unit must only be used when the axis is at a standstill.

The clamping unit may not be used as a braking unit!

Use for the emergency braking of a moving weight is not permissible.

Clamping during movement may lead to the destruction of the clamping unit as well as the linear guide!

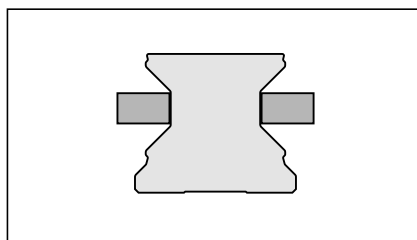
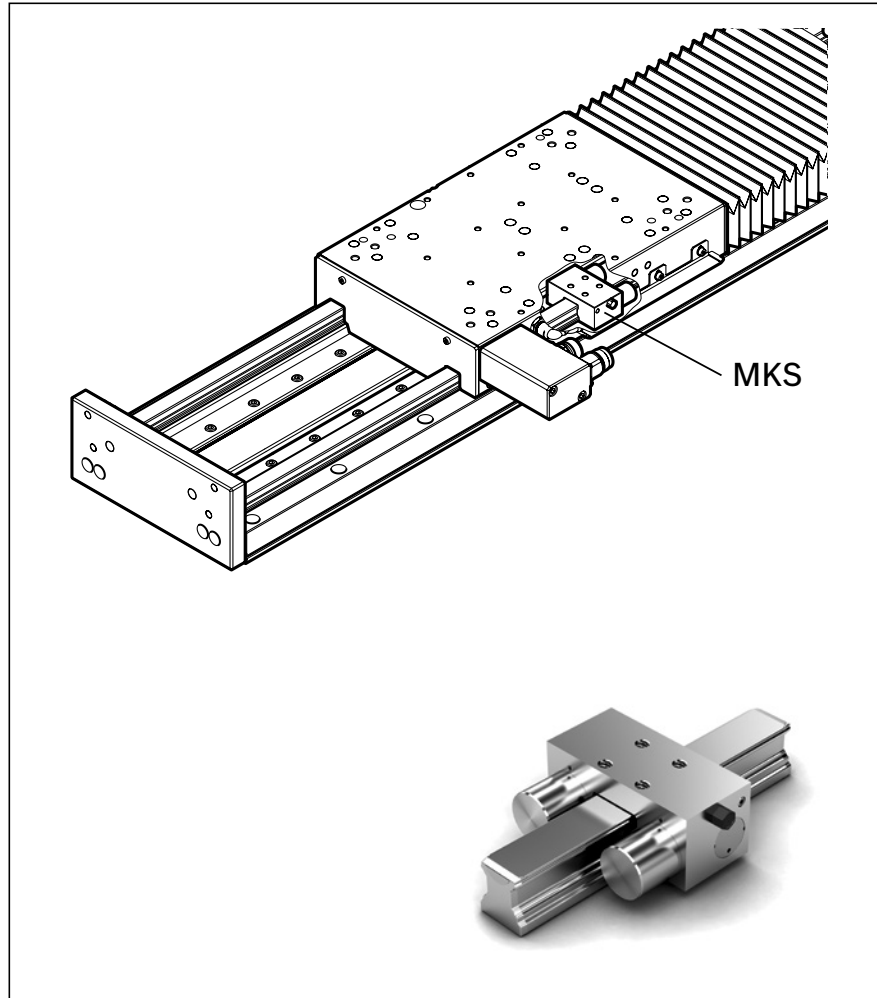

Air pressure: 0 bar

Clamps with spring force

In the event of pressure drop, the clamping profiles are pressed onto the guide rail by a spring energy accumulator. A quick-release valve for short reaction times is required.

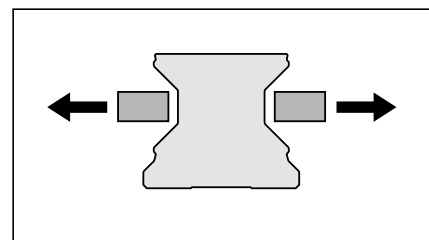

Air pressure: 5.5 - 6.5 bar

Decompression with air pressure

The clamping profiles are held apart by the compressed air.
– Free movement is possible

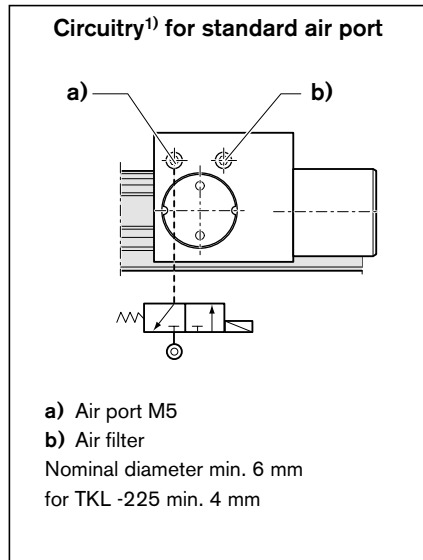

Size	TKL-225	TKL-275	TKL-325
Holding force spring mechanism¹⁾²⁾	600 N	750 N	1050 N
Pressure min. (release pressure)	5.5 bar		
Operating pressure	6.0 bar		
Max. pressure	6.5 bar		
Spring energy accumulator	✓		
Clamping cycles	up to 5 mill. (B10d-value) ³⁾		
Braking cycles	Not suitable		
Air port	Ø 4 mm		
Actuation	Pneumatic		
theor. air consumption per cycle at 6 bar	19 cm ³	21 cm ³	31 cm ³
Air quality	oiled air in accordance with ISO 8573-1 class 4, filter size 25 µm		

- 1) Static holding of the carriage with axial forces up to each specified value.
- 2) Holding force achieved by spring energy. The inspection is done in ready-mounted state with a lubricated layer (ISO-VG 68) on a hardened steel rail. Using other lubricants can impact the friction coefficient and thus the holding force.
- 3) The B10d-value specifies the number of switching cycles until 10% of components fail dangerously.

Connection overview

To connect a Ball Rail Table TKL to a Rexroth drive controller HCS, at least 2 prefabricated cables (power cable, encoder cable) are required. Extensions can also be used where necessary (e.g. routing in the cable drag chain).

The cooling hoses must also be taken into account with liquid cooling, the air hoses if a clamping unit is used and the electric cables if a switch is installed .

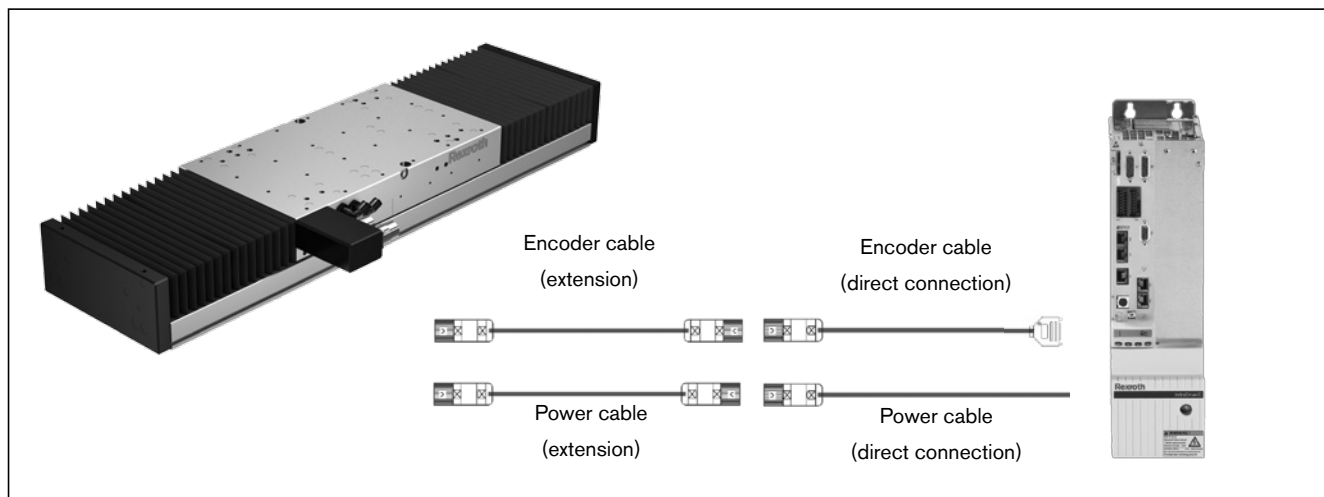

Power Cable

TKL	Motor	Rexroth Drive controller	Cable designation (raw cable)		Cross-section
			Extension	Direct connection	
TKL-225	MLP040A-0300	HCS02.1E-W0012/28	RKL4305 (INK 0653)	RKL4302 (INK 0653)	1.0 mm ²
		HCS02.1E-W0054		RKL4303 (INK 0653)	
	MLP040B-0250	HCS02.1E-W0012/28		RKL4302 (INK 0653)	
		HCS02.1E-W0054		RKL4303 (INK 0653)	
TKL-275	MLP070A-0300	HCS02.1E-W0012/28	RKL4311 (INK 0650)	RKL4306 (INK 0650)	1.5 mm ²
		HCS02.1E-W0054/70		RKL4307 (INK 0650)	
	MLP070B-0250	HCS02.1E-W0012/28		RKL4306 (INK 0650)	
		HCS02.1E-W0054/70		RKL4307 (INK 0650)	
TKL-325	MLP100A-0190	HCS02.1E-W0012/28	RKL4311 (INK 0650)	RKL4306 (INK 0650)	1.5 mm ²
		HCS02.1E-W0054/70		RKL4307 (INK 0650)	
	MLP100B-0250	HCS02.1E-W0054/70	RKL4312 (INK 0602)	RKL4309 (INK 0602)	2.5 mm ²
		HCS03.1E-W0100/150		RKL4310 (INK 0602)	
	MLP100C-0190	HCS02.1E-W0054/70	RKL4316 (INK 0603)	RKL4314 (INK 0603)	4.0 mm ²
		HCS03.1E-W0100/150		RKL4315 (INK 0603)	

Encoder cables

TKL (position measuring system)		Rexroth drive controller	Cable designation (raw cable)	
			Extension	Direct connection
-225 / -275 / -325	IMS-A (HIPERFACE ¹⁾)	Multi-encoder interface EC	RKG0057 (REG 0011)	RKG0055 (REG 0011)

1) HIPERFACE® is a registered trademark of SICK STEGMANN GmbH.

Technical data raw cables

Raw cable	Cross-section power cores (mm ²)	Diameter D (mm ²)	Weight of chain (kg/m)	Use E-chain	Bending radius		Bending cycles ¹⁾²⁾
					Fixed	Flexible	
INK 0653	1.0	12.0 ± 0.5	0.250	yes	5 x D	7.5 x D	5 million
INK 0650	1.5	12.2 ± 0.5	0.275				
INK 0602	2.5	14.8 ± 1.0	0.380				
INK 0603	4.0	17.0 ± 0.5	0.490		4 x D	7.5 x D	
REG 0011	—	10.0 ± 0.3	0.027				

1) Drag chain parameters: Acceleration max. 10m/s²; travel speed max. 5m/s; travel distance horizontal max. 50 m (maximum values only valid individually)

2) Changes to the above parameters (acceleration, speed, travel distance) will affect the service life of the cable or the number of bending cycles! Please consult us.

 Further instructions are available in the documentation for the linear motor, the drive controller and the connection cables.

Switching system

Overview

Item	
1	Mechanical switch (with additional components)
2	Switching cam
3	Cable duct (length max. 4m)
4	Proximity switch (with additional components)

Switching point distance

Distance between switch activation points of two switches

For switch combination	Min. spacing (mm)
mechanical - mechanical	60
mechanical - proximity	45
proximity - proximity	12.5

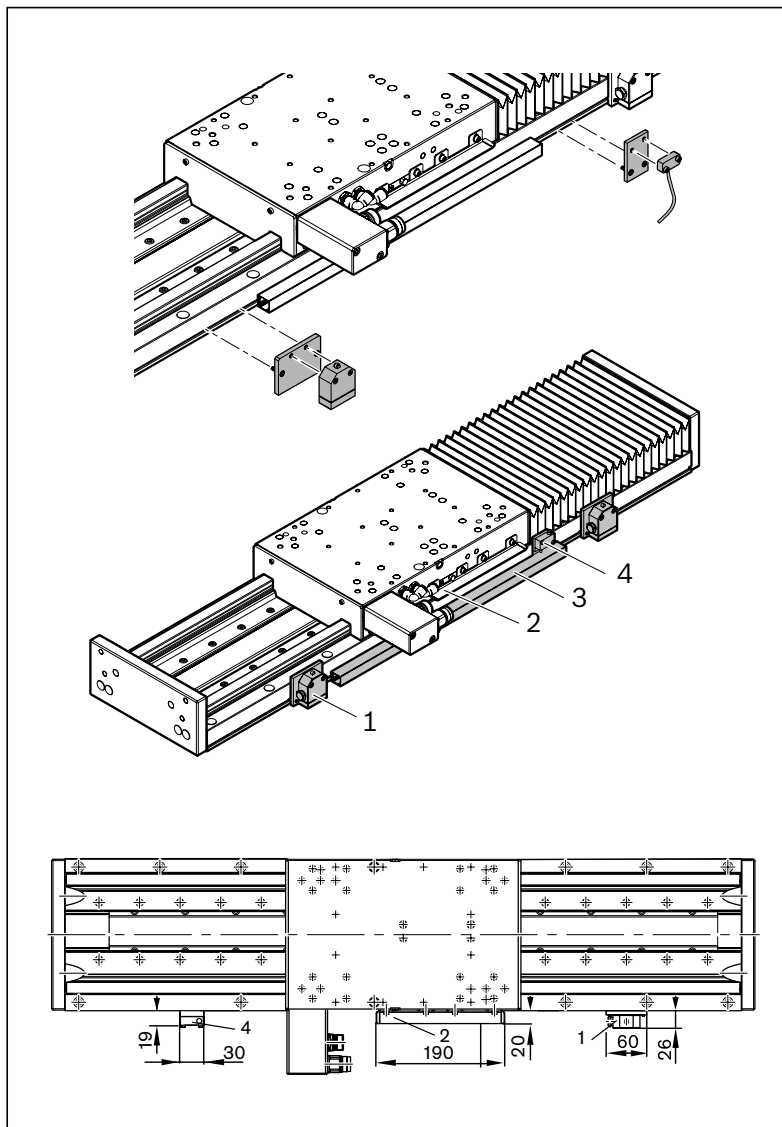

Cable duct

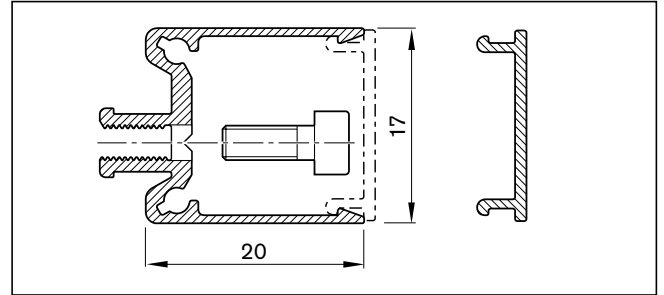

- The cable duct holds a maximum of two cables for mechanical switches and three cables for proximity switches.
- The duct is fixed by being clipped into the T-slot on the table and is secured by tightening the fixing screws.
- The fixing screws and cable grommets are supplied with the duct.



Switches and attachments

Item		Part number
1	Mechanical switches	see section on switches
	- Mounting components without switch	R117500165
2	Switching cam	R117500150
3	Cable duct (length max. 4 m)	R039662017, length mm
4	Proximity sensors	see section on sensors
	- Attachment parts (without sensors)	R117520152

Part numbers / technical data

Use	Limit switch	Reference switch	Limit switch	Reference switch
Part number	R901420149	R901420156	R901420152	R901420158
Designation	BES 517-351-NO-C-S49-00.2	BES 517-398-NO-C-S49-00.2	BES 517-352-NO-C-S49-00.2	BES 517-399-NO-C-S49-00.2
Functional principle	inductive			
Operating voltage	10–30 V DC			
Load current	≤ 200 mA			
Switching function	PNP/normally closed (NC)	PNP/normally open (NO)	NPN/normally closed (NC)	NPN/normally open (NO)
Connection type	Cable 0.2 m and plug M8 x 1, 3-pin with knurled screw			
Function indicator	✓			
Short-circuit protection	✓			
Reverse polarity protection	✓			
Switching frequency	2.5 kHz			
Max. permissible approach speed	depending on the switch tab			
Suitable for drag chains ¹⁾	–			
Torsion-resistant ¹⁾	–			
Weld spark-resistant ¹⁾	–			
Cable cross-section ¹⁾	3x0.14 mm ²			
Cable diameter D ¹⁾	3.5 ±0.15 mm			
Static bending radius ¹⁾	12 mm			
Dynamic bending radius ¹⁾	12 mm			
Bending cycles ¹⁾	–			
Ambient temperature	-40 °C to +70 °C			
Enclosure	IP65			
MTTFd (acc. to EN ISO 13849-1)	MTTFd = 830 years		MTTFd = 585 years	
Certifications and approvals ²⁾	  			

1) Technical data only for the cast-on connection line at the proximity sensor.

Extension cables are available for even more performance, e.g., for use in a power cable chain (see below).



2) No  certificate is required to introduce these products to the Chinese market.

Switches

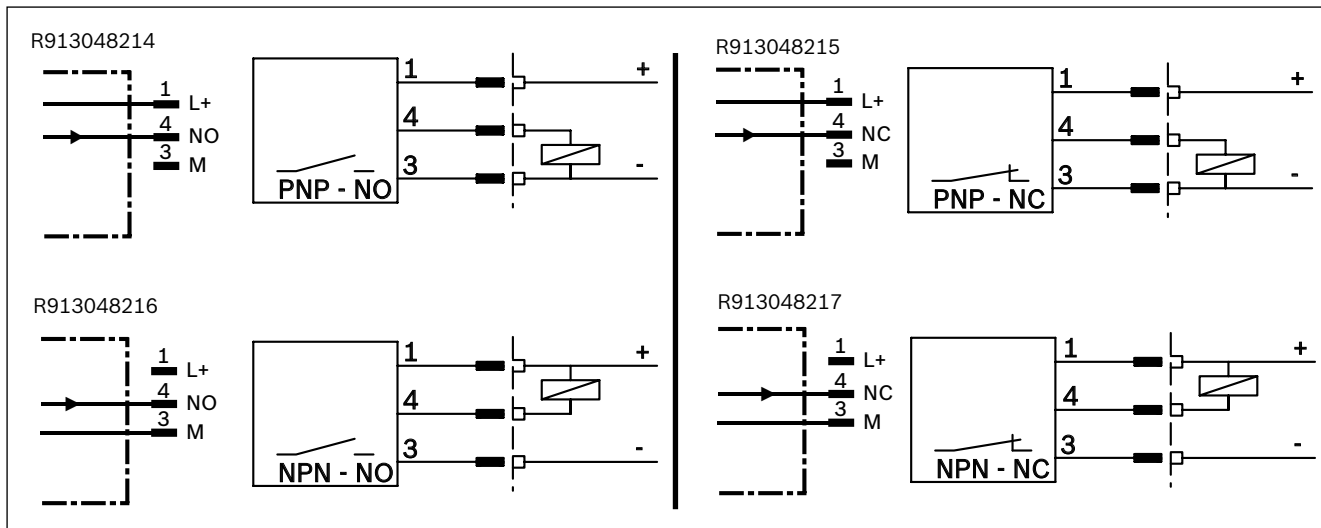
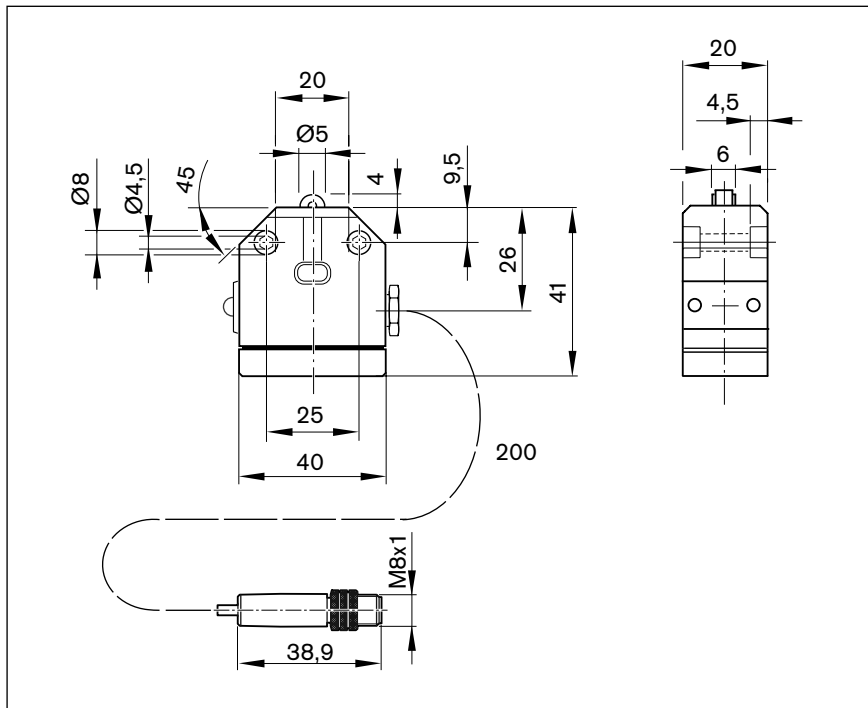
Mechanical switch with M8x1 plug



Part numbers / technical data

Use	Limit switch	Reference switch	Limit switch	Reference switch
Part number	R913048215	R913048214	R913048217	R913048216
Designation	BNS 819-X1002-99-R-10	BNS 819-X1001-99-R-10	BNS 819-X1004-99-R-10	BNS 819-X1003-99-R-10
Functional principle	mechanical, roller			
Operating voltage	10 - 30 VDC			
Load current	≤ 200 mA			
Switching function	PNP/normally closed (NC)	PNP/normally open (NO)	NPN/normally closed (NC)	NPN/normally open (NO)
Connection type	Cable 0.2 m and plug M8 x 1, 3-pin with knurled screw			
Function indicator	—			
Short-circuit protection	—			
Reverse polarity protection	—			
Switching frequency	3.3 Hz			
Max. perm. approach speed	1 m/s			
Suitable for drag chains ¹⁾	—			
Torsion-resistant ¹⁾	—			
Weld spark-resistant ¹⁾	—			
Cable cross-section ¹⁾	3x0.14 mm ²			
Cable diameter D ¹⁾	4.3 ±0.2 mm			
Static bending radius ¹⁾	12 mm			
Dynamic bending radius ¹⁾	12 mm			
Bending cycles ¹⁾	—			
Ambient temperature	-5 °C to +70 °C			
Enclosure	IP65			
B10d value	5x10 ⁶ (wet area); 10x10 ⁶ dependent on current load (dry area)			
Certifications and approvals ²⁾	  			

1) Technical data only for the cast-on connection line at the mechanical switch.

Extension cables are available for even more performance, e.g., for use in a power cable chain (see below).

2) No  certificate is required to introduce these products to the Chinese market.

Extensions

Pre-assembled on one side

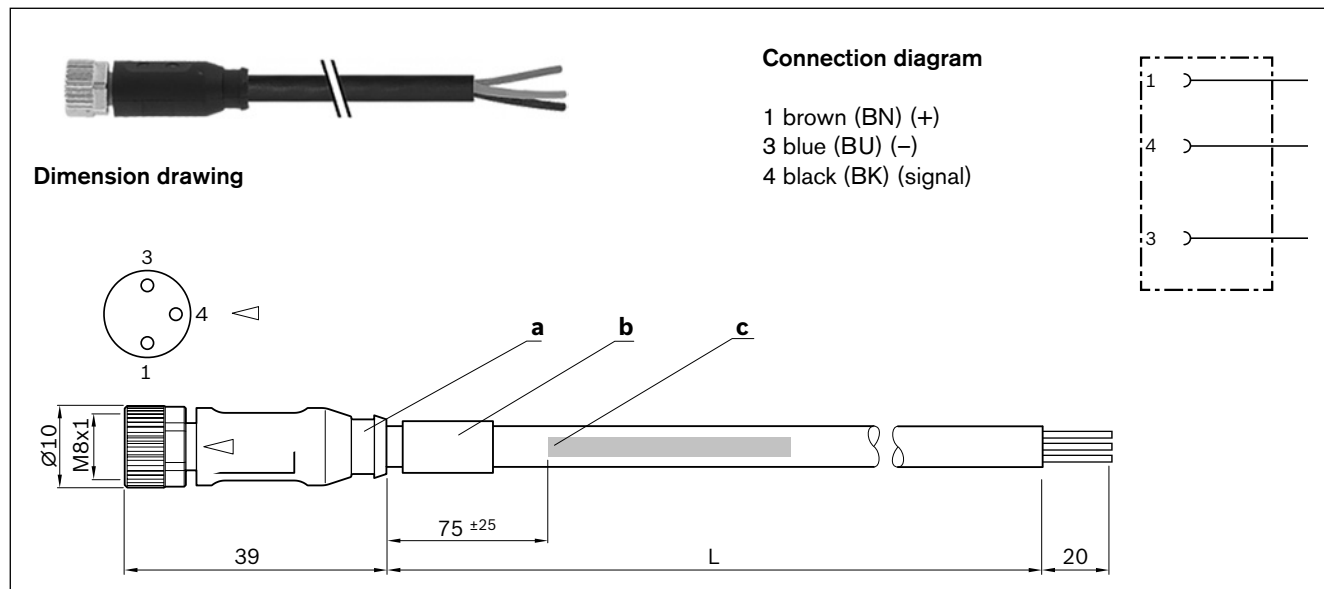

Part numbers

Use	Extension cable		
Part number	R911344602	R911344619	R911344620
Designation	7000-08041-6500500	7000-08041-6501000	7000-08041-6501500
Length (L)	0.5 m	10.0 m	15.0 m
1. Connection type	M8x1 3-pole straight female connector		
2. Connection type	Free cable end		

- a) Contour for 6.5 mm corrugated tube (inner diameter)
- b) Cable grommet
- c) Cable label in accordance with labeling regulation



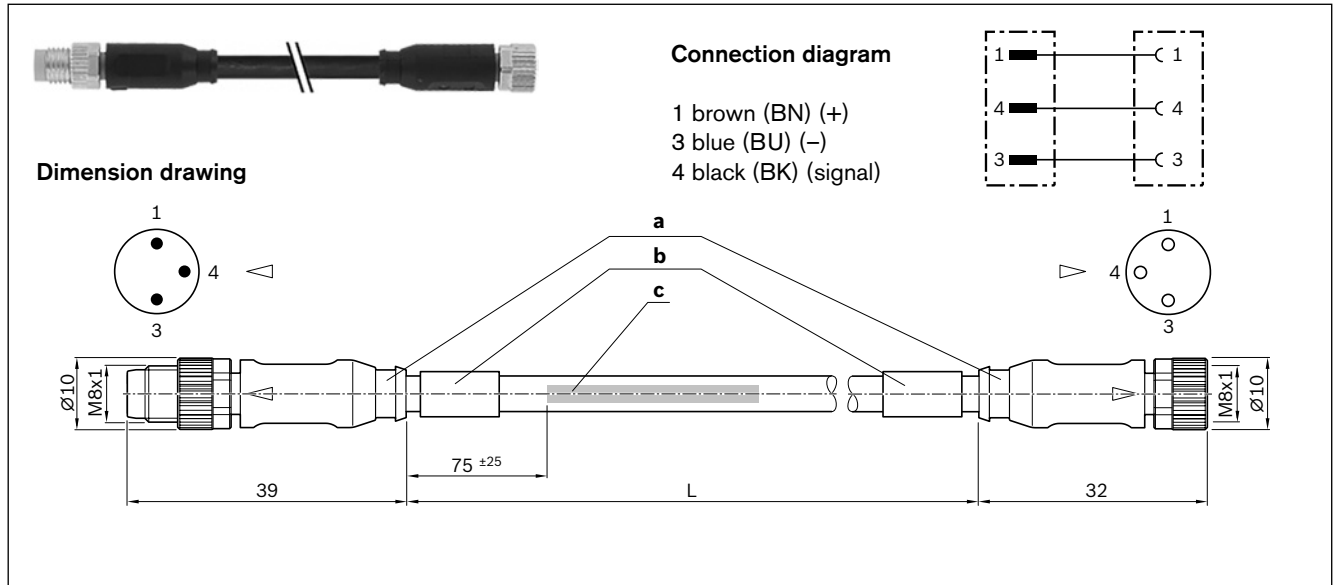

Pre-assembled on two sides



Part numbers

Use	Extension cable				
Part number	R911344621	R911344622	R911344623	R911344624	R911344625
Designation	7000-88001-6500050	7000-88001-6500100	7000-88001-6500200	7000-88001-6500500	7000-88001-6501000
Length (L)	0.5 m	1.0 m	2.0 m	5.0 m	10.0 m
1. Connection type	M8x1 3-pole straight female connector				
2. Connection type	Straight plug, M8x1, 3-pin				



Technical data for extensions pre-assembled on one or two sides

Function indicator	-
Operating voltage indicator	-
Operating voltage	10–30 V DC
Type of cable	PUR black
Suitable for drag chains	✓
Torsion-resistant	✓
Weld spark-resistant	✓
Cable cross-section	3 x 0.25 mm ²
Cable diameter D	4.1 ± 0.2 mm
Static bending radius	5xD
Dynamic bending radius	10xD
Bending cycles	> 10 mil.
Max. permissible travel speed	3.3 m/s - at 5 m travel range (type) up to 5 m/s at 0.9 m travel range
Max. permissible acceleration	30 m/s ²
Ambient temperature when secured	-40 °C to +85 °C
Ambient temperature when loose	-25 °C to +85 °C
Enclosure	IP68
Certifications and approvals	    

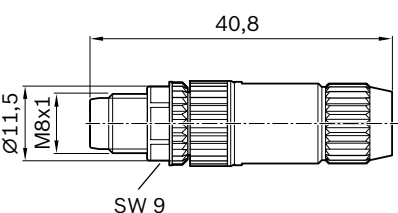
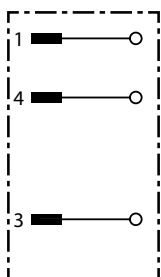
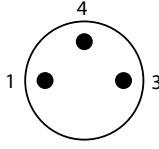

- a) Contour for 6.5 mm corrugated tube (inner diameter)
- b) Cable grommet
- c) Cable label in accordance with labeling regulation

Extensions

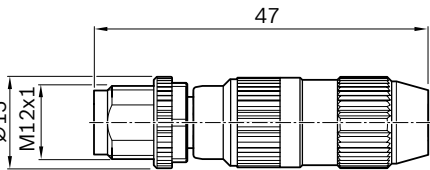
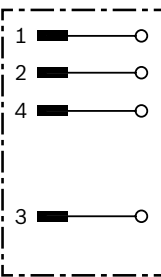
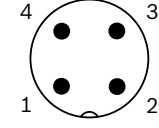
Plug

 <p>R901388333</p>	<p>Dimension drawing</p> 	<p>Connection diagram</p> 	<p>Connector side view</p> 
 <p>R901388352</p>	<p>Dimension drawing</p> 	<p>Connection diagram</p> 	<p>Connector side view</p> 

Part numbers / technical data

Use	Single plug	
Part number	R901388333	R901388352
Designation	7000-08331-0000000	7000-12491-0000000
Version	straight	
Operating current per contact	max. 4 A	
Operating voltage	max. 32 V AC/DC	
Connection type	Straight plug, M8x1, 3-pin, IDC, self-locking screw	Straight plug, M12x1, 4-pin, IDC, self-locking screw
Function indicator	-	
Operating voltage indicator	-	
Connection cross-section	0.14 ... 0.34 mm ²	
Ambient temperature	-25 °C to +85 °C	
Enclosure	IP67 (plugged in & screwed down)	
Certifications and approvals	  	

Adapter



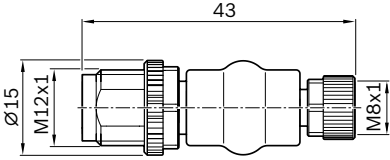

R911344591

Dimension drawing

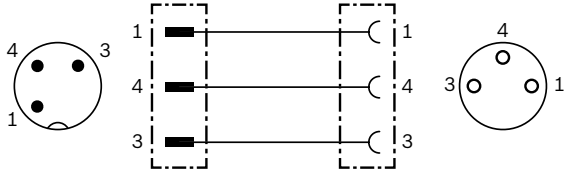

Connection diagram





R911344592

Dimension drawing

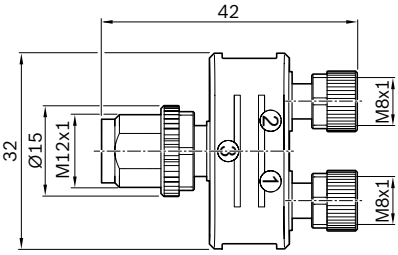



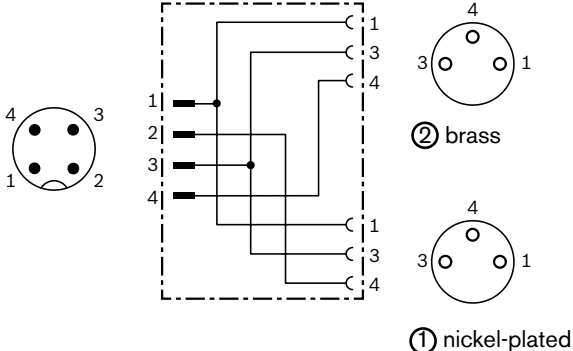

Connection diagram



① nickel-plated
② brass

Part numbers / technical data

Use	Adapter	Adapter or distributor
Part number	R911344591	R911344592
Designation	7000-42201-0000000	7000-41211-0000000
Version	straight for 1 sensor	Straight, for 1 - 2 sensors
Operating current per contact	max. 4 A	
Operating voltage	max. 32 V AC/DC	
1. Connection type	Straight female connector, M8x1, 3-pin, self-locking screw thread	2 X straight female connectors, M8x1, 3-pin, self-locking screw thread
2. Connection type	Straight plug, M12x1, 3-pin, self-locking screw thread	Straight plug, M12x1, 4-pin, self-locking screw thread
Function indicator	-	
Operating voltage indicator	-	
Connection cross-section	-	
Ambient temperature	-25 °C to +85 °C	
Enclosure	IP67 (plugged in & screwed down)	
Certifications and approvals		  

Distributors

Passive distributor

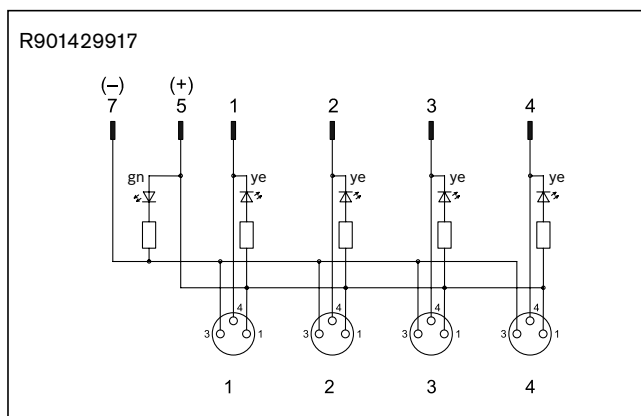
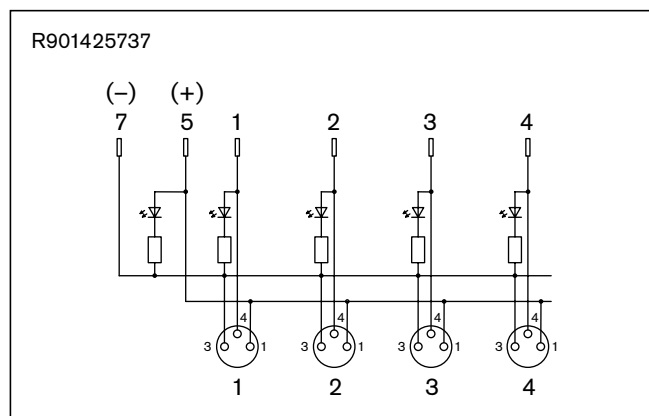
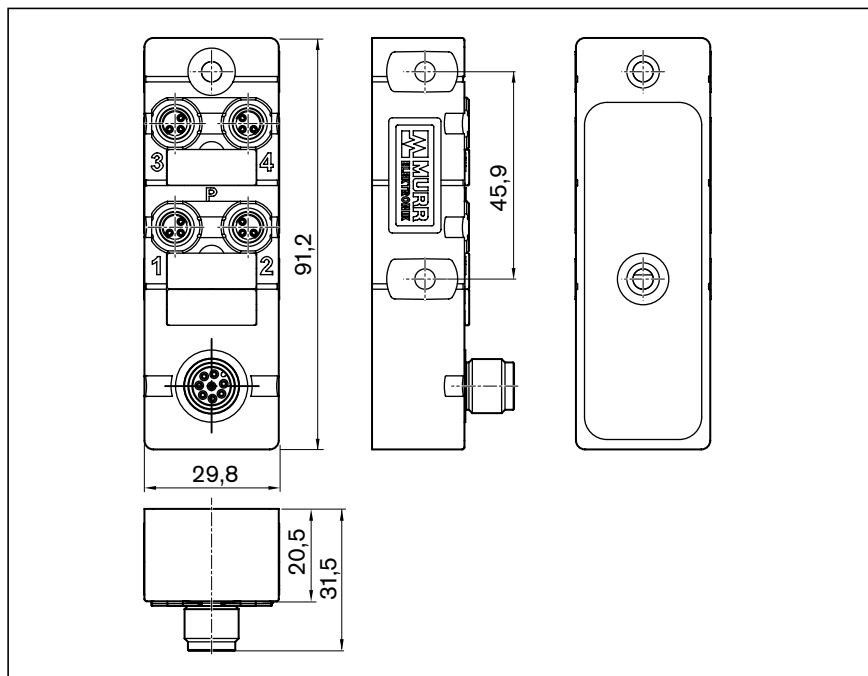

Part numbers / technical data

Use	Passive distributor		
Part number	R901425737	R901429917	R911344592
Designation	8000-84070-0000000	8000-84071-0000000	
Version	Straight, for 1 - 4 sensors		
Operating current per contact	max. 2 A		
Operating voltage	24 V DC		
Switching logic	PNP	NPN	
1. Connection type	4x straight female connector, M8x1, 3-pin, IDC, self-locking screw thread		
2. Connection type	Straight plug, M12x1, 8-pin, IDC, self-locking screw thread		
Function indicator	✓		
Operating voltage indicator	✓		
Connection cross-section	-		
Ambient temperature	-20° to +70 °C		
Enclosure	IP67 (plugged in and screwed down)		
Certifications and approvals			

See the adapter for technical data and drawing

Attachment parts for passive distributors

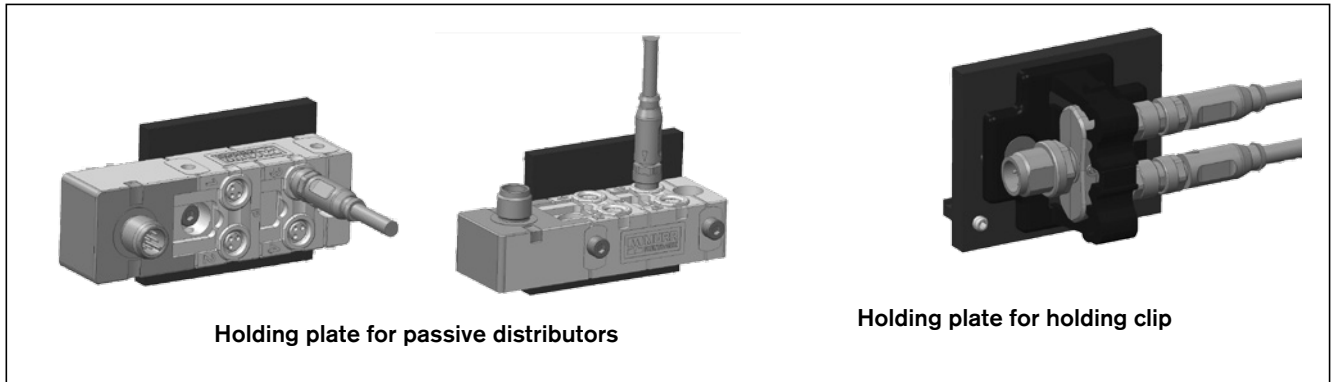

Part numbers

Use	For passive distributors R901425737/R901429917	For passive distributor R911344592
Holding plate	R117500167	R117500166

Accessories for passive distributors

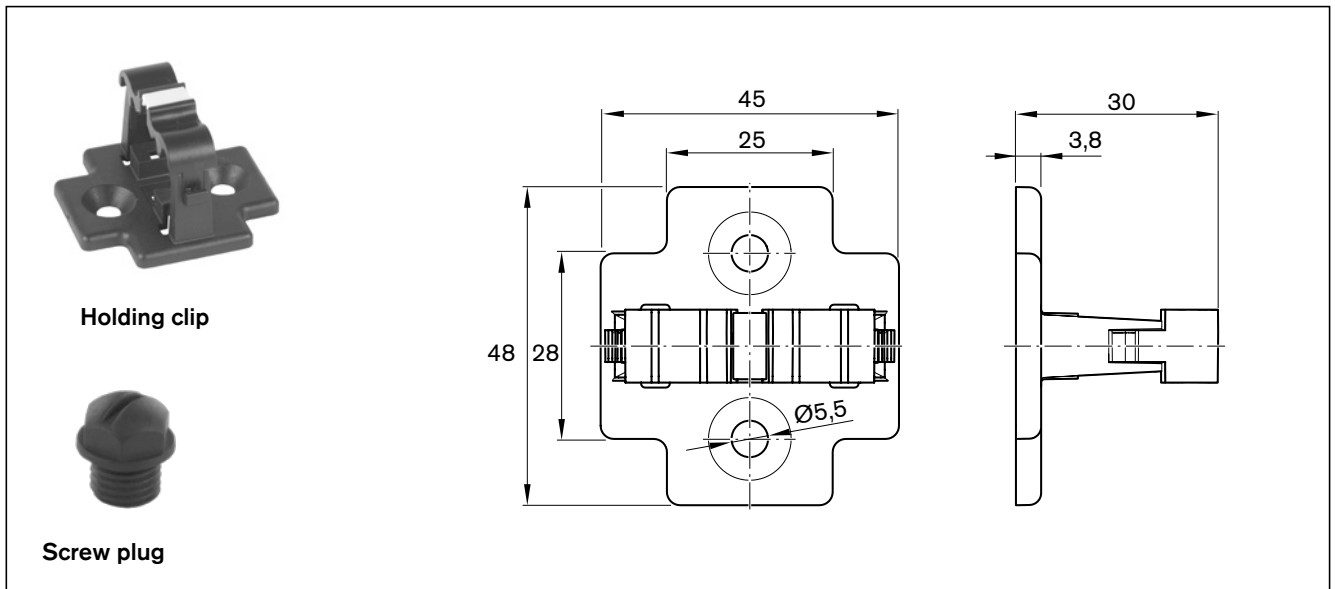

Part numbers / technical data



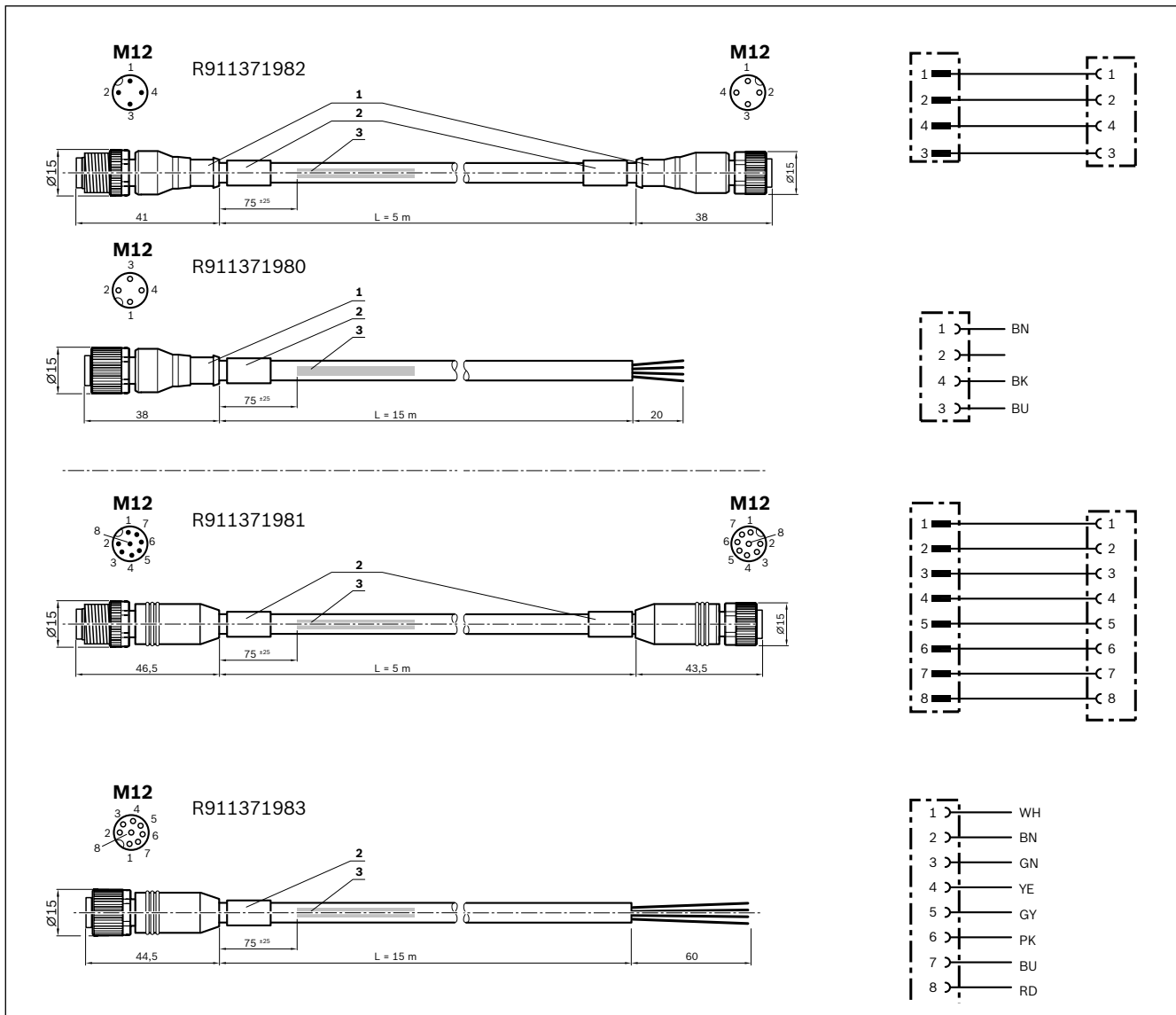
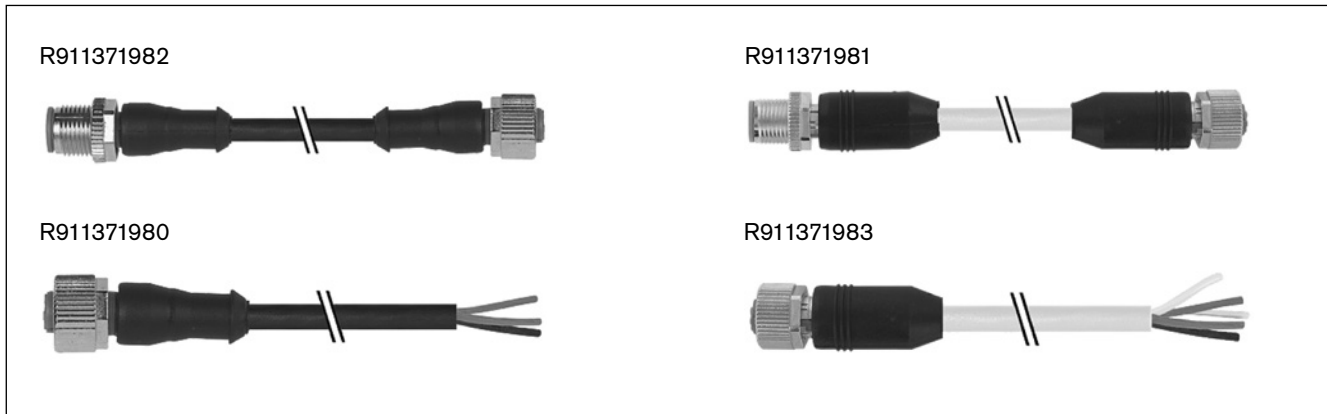

Use	For passive distributors R901425737/R901429917	For passive distributor R911344592
Holding clip	-	R913047341
Designation	-	7000-99061-0000000
Set	-	1 pc.
Screw plug	R913047322	-
Designation	3858627	-
Set	10 pcs.	-

Extensions for passive distributors

Extensions for passive plugs



Part numbers / technical data

Use	Extension cable for passive distributor R911344592		Extension cable for passive distributors R901425737/R901429917	
Part number	R911371982	R911371980	R911371981	R911371983
Designation	7000-40021-6540500	7000-12221-6541500	7000-48001-3770500	7000-17041-3771500
Length	5.0 m	15.0 m	5.0 m	15.0 m
1. Connection type	Straight female connector, M12x1, 4-pin		Straight female connector, M12x1, 8-pin	
2. Connection type	Straight plug, M12x1, 4-pin	Free cable end	Straight plug, M12x1, 8-pin	Free cable end
Function indicator	-			
Operating voltage indicator	-			
Type of cable	PUR black		PUR gray	
Operating voltage	30 V AC/DC			
Operating current per contact	max. 4 A per contact		max. 2 A per contact	
Suitable for drag chains	✓			
Torsion-resistant	✓			
Weld spark-resistant	✓			
Cable cross-section	4 x 0.34 mm ²		8 x 0.34 mm ²	
Cable diameter D	4.7 ± 0.2 mm		6.2 ± 0.3 mm	
Static bending radius	≥ 5 x D			
Dynamic bending radius	≥ 10 x D			
Bending cycles	> 10 mill.			
Max. permissible travel speed	3.3 m/s - at 5 m travel range (type) up to 5 m/s at 0.9 m travel range			
Max. permissible acceleration	≤ 30 m/s ²			
Ambient temperature when secured	-40 °C to +80 °C (90 °C max. 10 000 h)			
Ambient temperature when loose	-25 °C to +80 °C (90 °C max. 10 000 h)			
Enclosure	IP67 (plugged in & screwed down)			
Certifications and approvals	    			

Combination examples

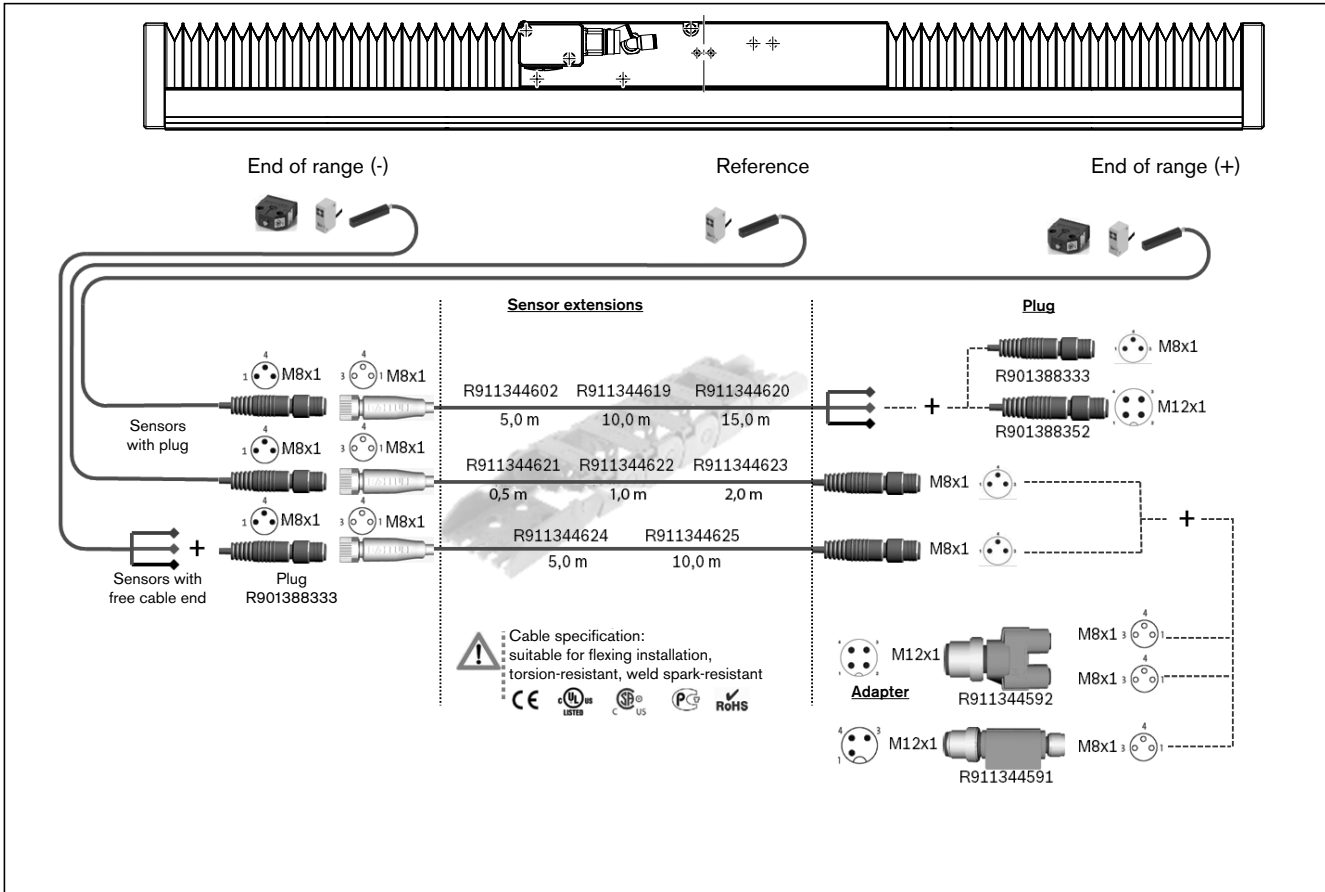

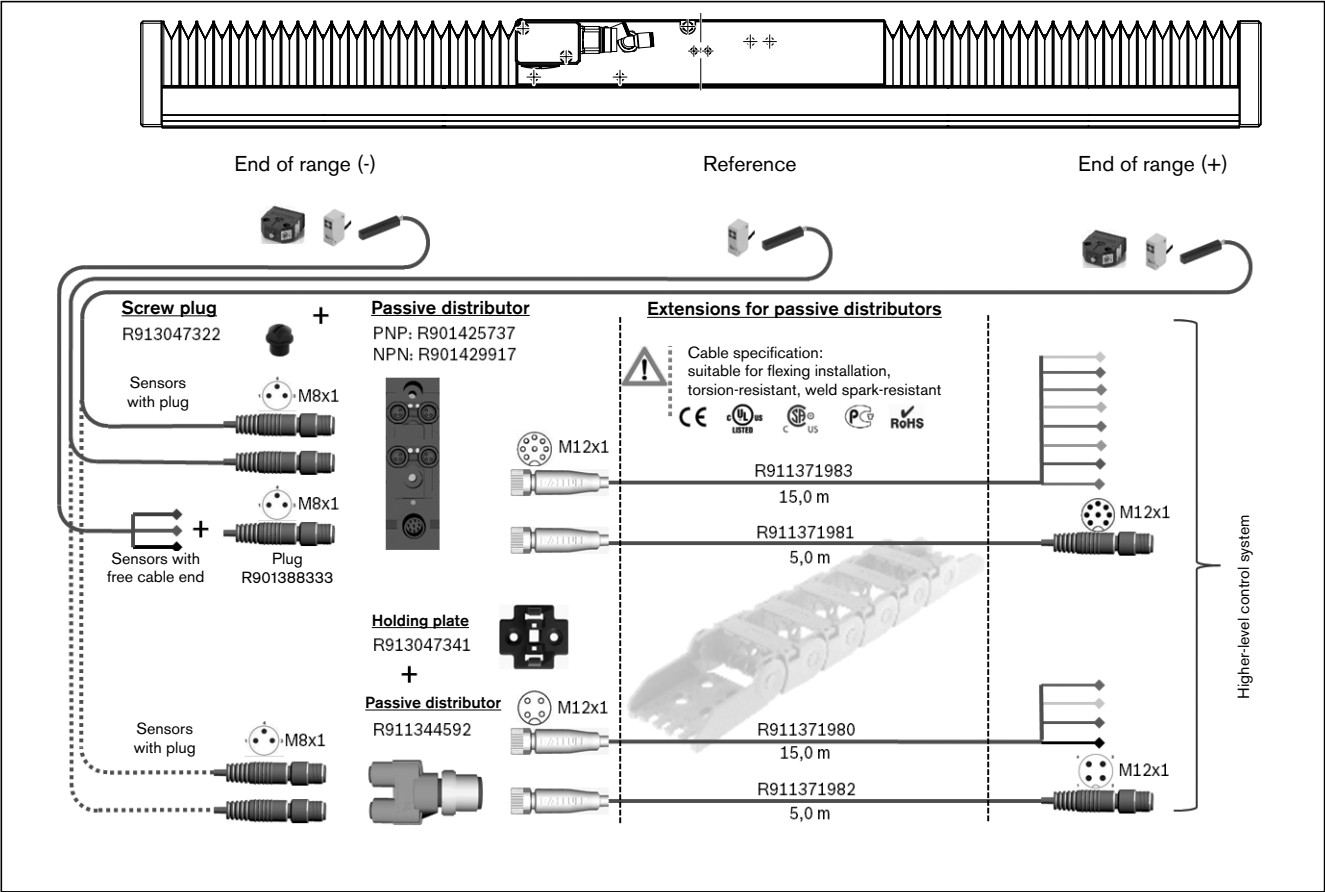

Accessories

Cable drag chain

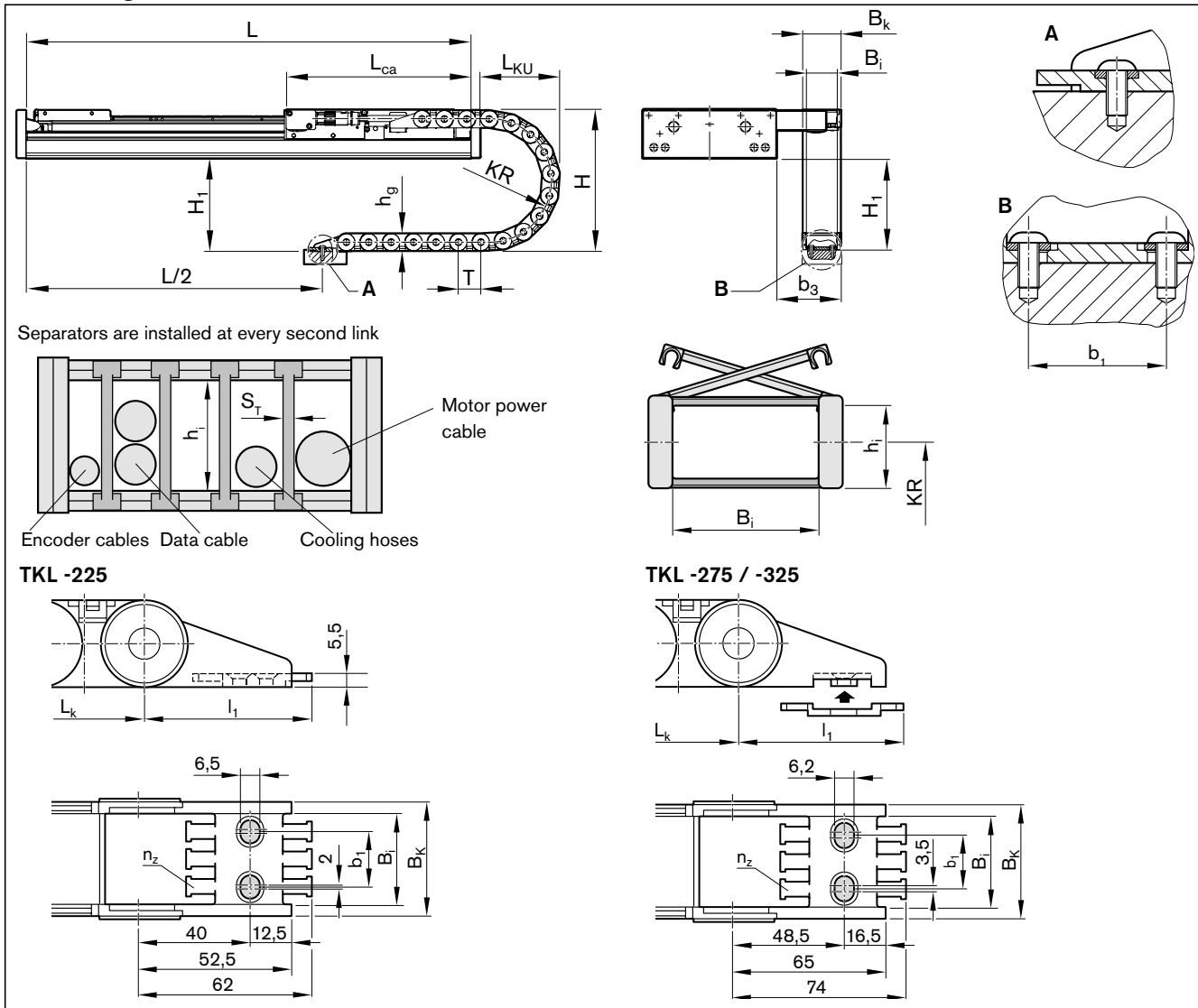

TKL	Part number	Assembly kit	Dimensions (mm)														Max. accel. a_{perm} (m/s ²)	Weight of chain m_c (kg/m)				
			Cable drag chain 1 m sections		Mounting accessories		b_1	b_3	B_1	B_k	H	H_1	h_g	h_i	KR	L_{ku}			n_z	S_T	T	Z
TKL-225	A R345403079	R141400023			36	104	50	63	228	130	28	20	100	100	4	2.0	34.5	475	50	0.53		
TKL-275	A R345403095	R141400024			44	121	58	76	286	180	36	26	125	150	4	2.5	45.5	610	50	0.95		
TKL-325	A R345403095	R141400024			44	121	58	76	286	170	36	26	125	50	4	2.5	45.5	561	50	0.95		

Dead weight of the supply lines in the cable drag chain

TKL	-225	-275	-325
With cooling line (kg/m)	0.6	0.7	0.9
Without cooling line (kg/m)	0.4	0.5	0.7

Number of chain links n_c
Round up the result.

$$n_c = \frac{0.5 \cdot (L - L_{ca}) + Z}{T}$$

n_c = number of chain links
 L = length of linear motion system
 L_{ca} = length of carriage

Chain length L_c
(without connectors)

$$L_c = n_c \cdot T$$

L_c = chain length
 T = chain pitch

Calculation of chain length (example)

$$n_c = \frac{0.5 \cdot (1660 - 400) + 492}{34.5}$$

$n_c = 32.52$ round up to 33

$L_c = n_c \cdot T = 33 \cdot 34.5 \text{ mm} = 1122 \text{ mm}$ round up to 2000 mm = 2 round up to (m)

Self-supporting length L_f

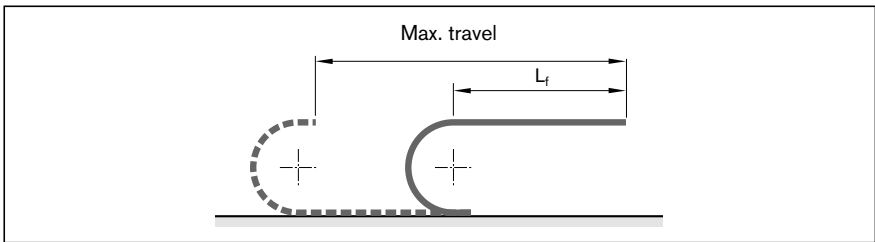

TKL-225

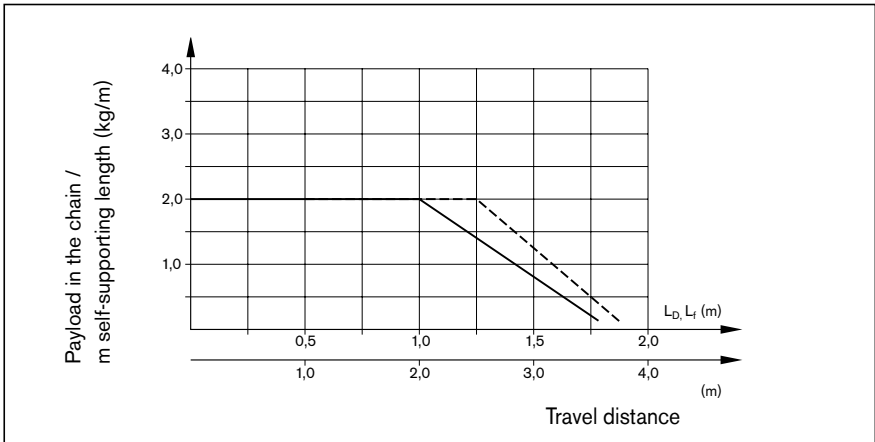

TKL-275 / TKL-325

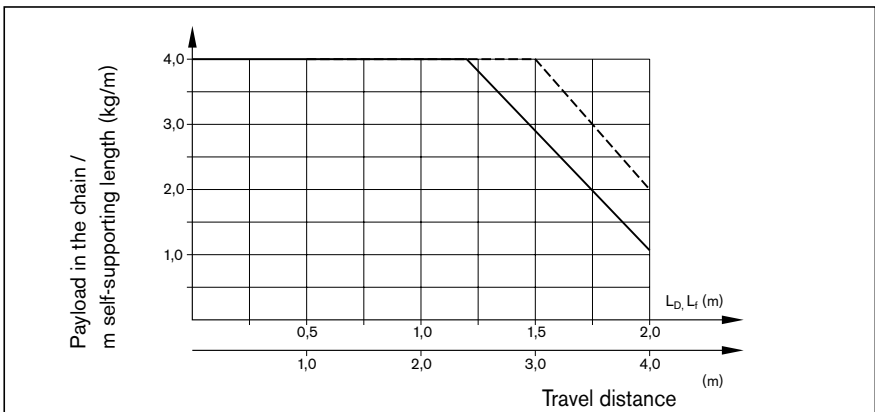

—— L_f = self-supporting length
- - - L_D = length with permissible sag

Documentation

Note: The measurements are taken with the unit screwed down and assuming an ideally flat mounting base surface.

Standard report Option 01

The standard report serves to confirm that the checks listed in the report have been carried out and that the measured values lie within the permissible tolerances.

Checks listed in the standard report:

- functional checks of mechanical components
- functional checks of electrical components
- design is in accordance with order confirmation

Frictional force of complete system Option 02

The moment of friction force is measured over the entire travel range.

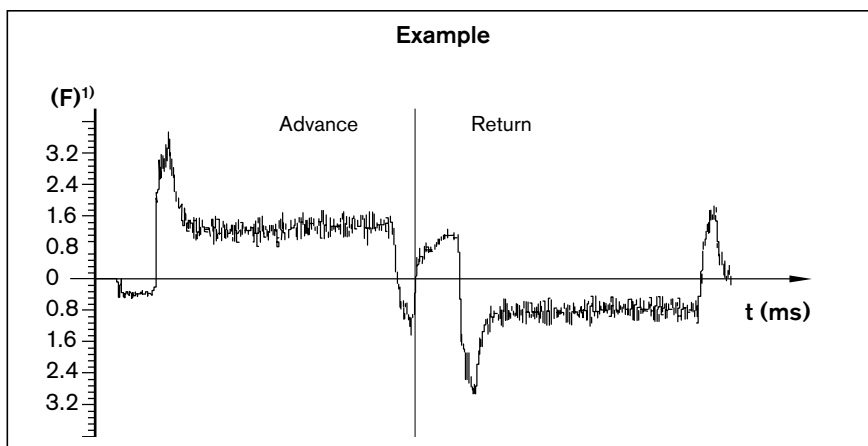

1) In % of F_{dN} = continuous force

Travel accuracy Option 04

Several measuring points are passed during the total travel. The following deviations are determined:

Yawing

Yawing is angular deviation about the vertical axis. This angular deviation is converted to a linear deviation in mm on the basis of a standard length and is plotted on the graph. The base length is given in the diagram.

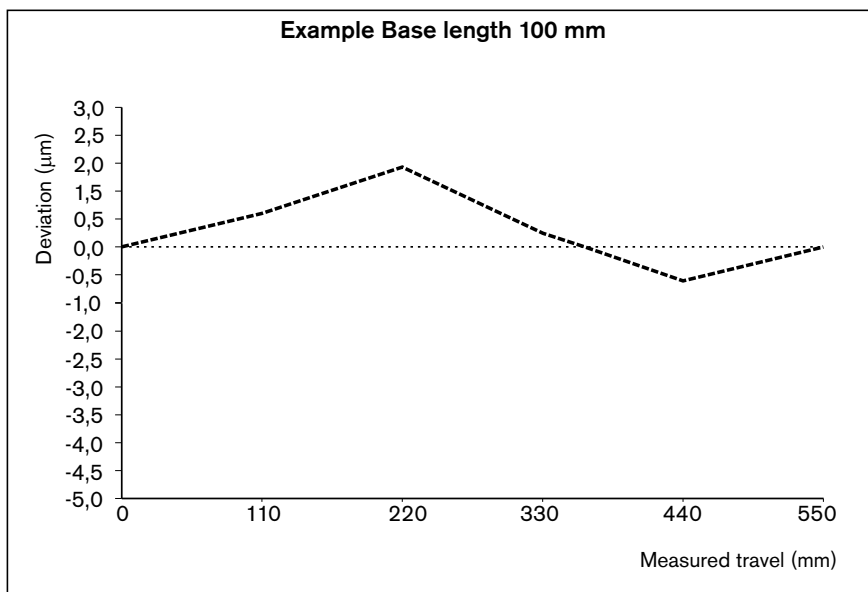
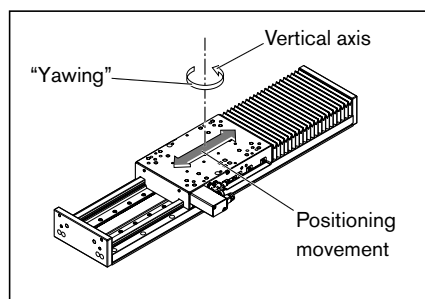

Pitching

Pitching means angular deviation about the horizontal axis. This angular deviation is converted to a linear deviation in mm on the basis of a standard length and is plotted on the graph. The base length is given in the diagram.

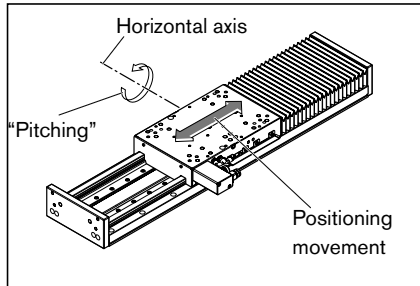

In addition to graphical representation (see illustrations), a measurement report is supplied in table form.

Positioning accuracy to VDI/DGQ 3441 Option 05

Measurement points are selected at irregular intervals along the travel. This enables even periodical deviations to be detected during positioning. Each measurement point is approached several times from both sides. This will give the following parameters.

Positioning accuracy P

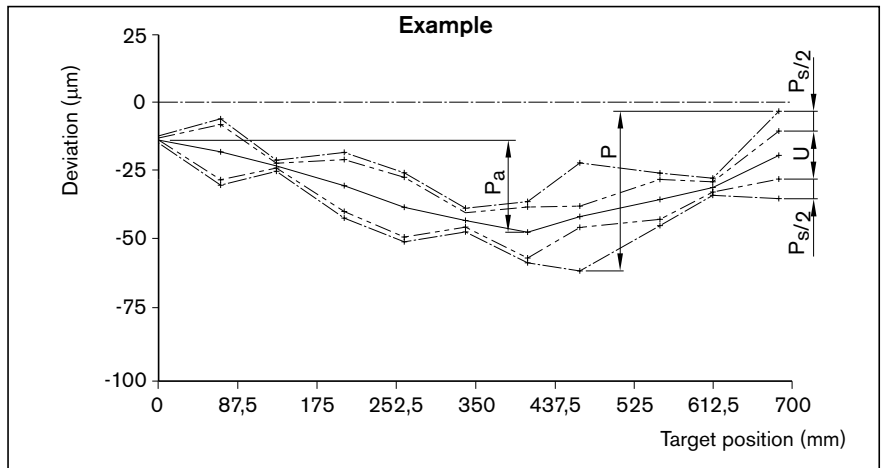
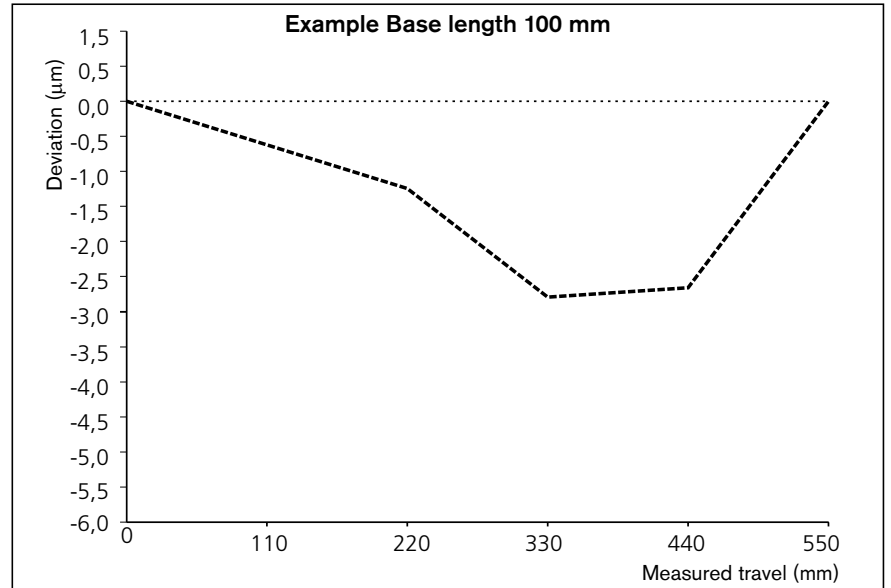

The positioning accuracy corresponds to the total deviation. It encompasses all the systematic and random deviations during positioning. The positioning accuracy takes the following characteristic values into consideration:

- positioning deviation
- reversal range
- position variation range

Positioning deviation P_a

The positioning deviation corresponds to the maximum difference arising in the mean values of all the measurement points. It describes systematic deviations.

Reversal range U

The reversal range corresponds to the difference in mean values of the two approach directions. The reversal range is determined at every measurement point. It describes systematic deviations.

Position variation range P_s

The position variation range describes the effects of random deviations. It is determined at every measurement point.

Lubrication

Lubrication notes

⚠ **The one-point lubrication connection of Ball Rail Tables TKL is designed for grease lubrication only!**

Basic lubrication is applied in-factory before shipment.

The only maintenance required is re-lubrication of the guideway via the two lube ports (1) using a manual grease gun with extension tube.

For further information on lubricants / lubrication intervals, see instruction manual.

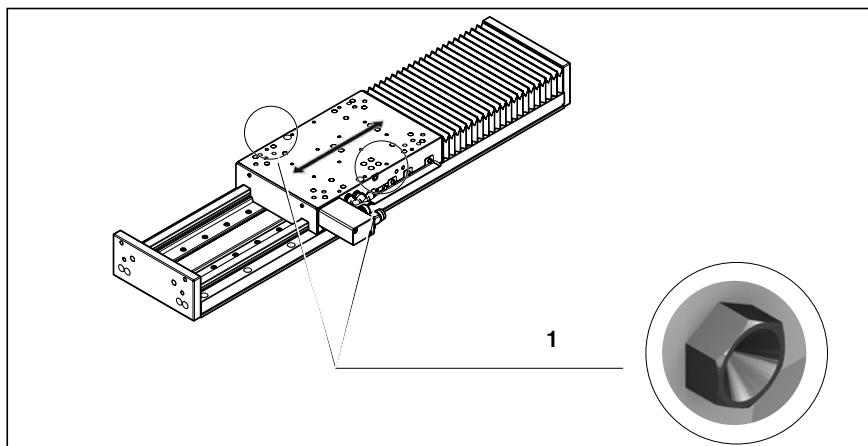

Normal operating conditions

Normal operating conditions

Ambient temperature	0 °C ... 40 °C
Defrost	no
Load	See technical data
Travel speed	with High Precision Ball Runner Blocks, max. 5 m/s

Order example

Ordering data	Description
Ball Rail Table TKL -225	Ball Rail Table
(Part number): R1450 305 10, 1660 mm	TKL -225, length 1660 mm
Version = IM01	with integrated position measuring system, as shown in diagram IM01
Guideway = 03	Ball Rail Systems
Drive = 17	with primary part B with motor winding 0250
Carriage = 12	one carriage 400 mm long, Standard Ball Runner Blocks, preload 8%
Cover = 01	with polyurethane bellows
Position measuring system = 25	with integrated position measuring system IMS-A
End position damping = 22	with buffers and clamping unit
1. Switches = 111 -A + 400 mm	proximity sensor, PNP NC, in switching position + 400 mm
2. Switches = 111 -A - 400 mm	proximity sensor, PNP NC, in switching position - 400 mm
Cable duct = 20 1500 mm	cable duct 1500 mm long (loose)
Switching cam = 16	with switching angle (for switch actuation)
Documentation = 01	with standard report

Inquiry/order form

Bosch Rexroth AG
Linear Motion and Assembly Technologies
D-97419 Schweinfurt, Germany

Telephone +49-9721-937-0

Fax (0 97 21) 9 37-350
(direct)

Rexroth Ball Rail Tables TKL

To be completed by customer: Inquiry /Order

Ball Rail Table TKL _____

(Part number): _____ - _____ - _____, length _____ mm

Type =

Guideway =

Drive =

Carriage =

Cover =

Position measuring system =

End cushioning =

Switch 1 = - mm

Switch 2 = - mm

Cable duct = - mm

Switching cam =

Documentation =

Quantity Acceptance of: _____ pcs, _____ per month, _____ per year, per order, or _____

Comments:

From

Company: _____

Responsible: _____

Address: _____

Department: _____

Phone: _____

Fax: _____

Further information

Bosch Rexroth homepage:

<http://www.boschrexroth.de>



Product information Ball Rail Tables TKL:

<https://www.boschrexroth.com/de/de/produkte/produktgruppen/lineartechnik/linearsysteme/schienenfuehrungstische/index>



Product configurators:

<https://www.boschrexroth.com/de/de/produkte/produktsupport/konfiguratoren-und-tools/index>



< Produkte

< Produktsupport

Konfiguratoren und Tools >

Konfiguratoren und Tools

Nutzerorientiert, übersichtlich und umfassend: Bosch Rexroth bietet eine Vielzahl an Hilfsmitteln, um die Identifikation bzw. Konfiguration passender Produktlösungen zu unterstützen.

Von der Auswahl vorhandener Standardprodukte bzw. über die individualisierte Variantenerstellung bis hin zur Beschleunigung der Engineering- & Bestellprozesse können Sie aus einem umfangreichen Toolportfolio wählen.

Produktkonfiguratoren

- Rund um die Uhr erreichbar
- Umfassende Konfigurationsdokumentation (einschließlich CAD-Dateien)
- Konfiguration über Materialnummer, Typenbezeichnung oder Funktion

Engineering Tools

- Erweiterte Funktionen (Planung, Konstruktion, Berechnung ...)
- Offline-Verfügbarkeit
- Support beim Einkaufsprozess

- > Allgemein
- > Montagetechnik
- > Elektrische Antriebe und Steuerungen
- > Industriehydraulik
- ▼ Lineartechnik

Produktkonfiguratoren	Engineering Tools
<ul style="list-style-type: none"> Kugelbüchsenführungen → Präzisions-Stahlwellen Profilschienerführungen → Führungswagen → Kugel- und Rollerschienerführungen mit integriertem Messsystem IMS Gewindetriebre → Kugelgewindetriebre KGT → Planetengewindetriebre PLSA Linearsysteme → Compact Module CKx → Omegamodul OBB → Präzisionsmodul PSK 	<ul style="list-style-type: none"> → Linear Motion Designer → LinSelect

Bosch Rexroth AG

Ernst-Sachs-Straße 100
97424 Schweinfurt, Germany
Tel. +49 9721 937-0
Fax +49 9721 937-275
www.boschrexroth.com

Find your local contact person here:

www.boschrexroth.com/contact

